

Charles Selwitz

**Epoxy Resins  
in Stone Conservation**

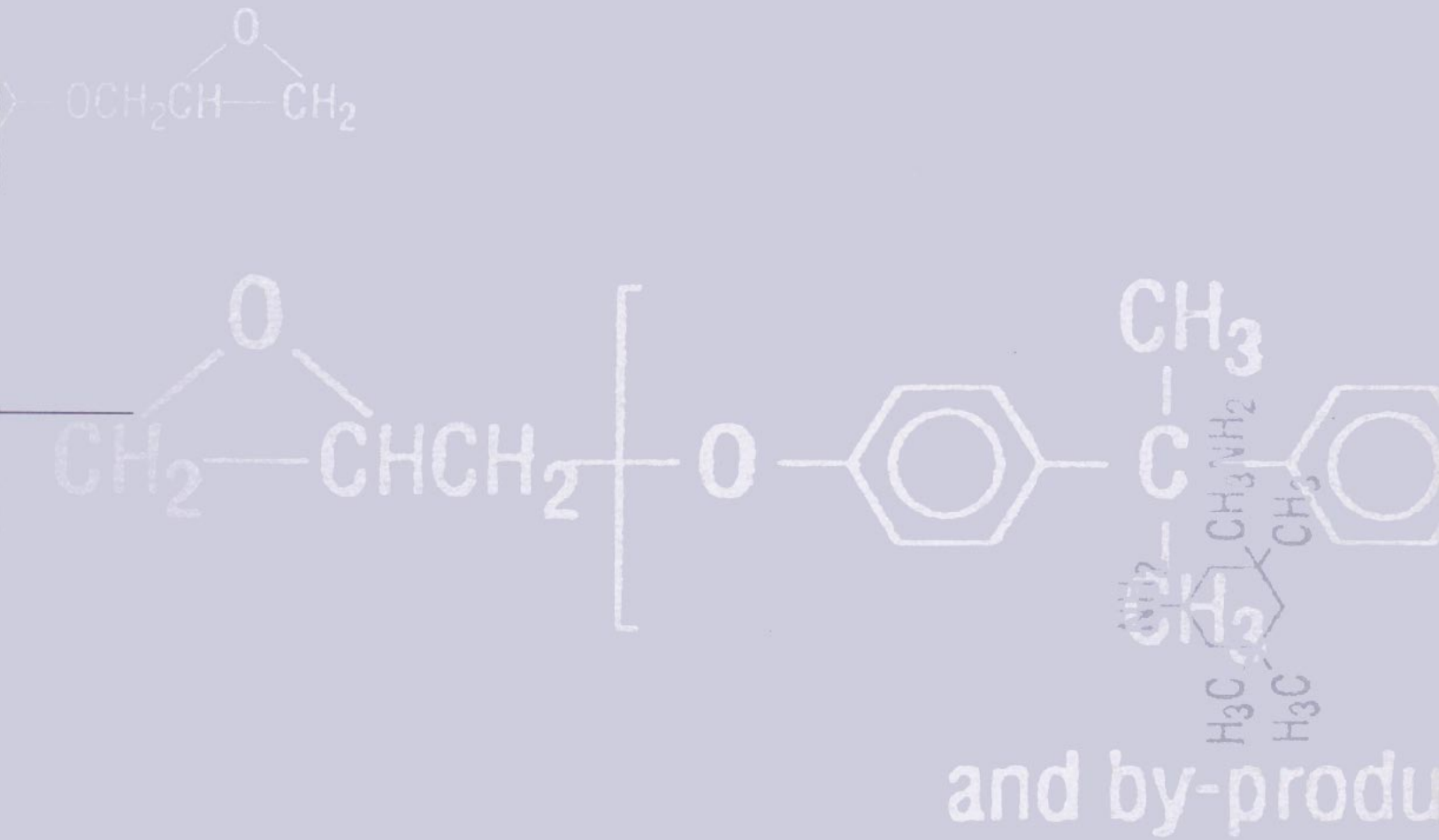

## **Epoxy Resins in Stone Conservation**

---

Charles Selwitz

**Epoxy Resins  
in Stone Conservation**

Editor: Irina Averkieff  
Cover design: Joe Molloy  
Text design, coordination, and supervision: Irina Averkieff  
Typography: FrameMaker / Adobe Palatino and Helvetica Condensed  
Computer illustrations: Ann Zumwinkle  
Photography: Charles Selwitz (except where credited otherwise)  
Printing: Westland Graphics

© 1992 by the J. Paul Getty Trust. All rights reserved  
Printed in the United States of America.

Library of Congress Cataloging-in-Publication Data

Selwitz, Charles, 1927

Epoxy resins in stone consolidation / Charles Selwitz.

p. cm. — (Research in conservation : 7)

Includes bibliographical references and index.

ISBN 0-89236-238-3 (pbk.)

1. Stone buildings—Conservation and restoration. 2. Building stones—Deterioration. 3. Epoxy resins. I. Title. II. Series.

TH1201.S45 1992

693'.1--dc20

92-8427

CIP

## **The Getty Conservation Institute**

The Getty Conservation Institute (GCI), an operating program of the J. Paul Getty Trust, was created in 1982 to enhance the quality of conservation practice in the world today. Based on the belief that the best approach to conservation is interdisciplinary, the Institute brings together the knowledge of conservators, scientists, and art historians. Through a combination of in-house activities and collaborative ventures with other organizations, the Institute plays a catalytic role that contributes substantially to the conservation of our cultural heritage. The Institute aims to further scientific research, to increase conservation training opportunities, and to strengthen communication among specialists.

## **Research in Conservation**

This reference series is born from the concern and efforts of the Getty Conservation Institute to publish and make available the findings of research conducted by the GCI and its individual and institutional research partners, as well as state-of-the-art reviews of conservation literature. Each volume will cover a separate topic of current interest and concern to conservators.



*Professor Petr Kotlik (right) and his assistant are heat-sealing polyethylene film to create a containment chamber around a limestone statue as part of a routine program for treating statuary with epoxy resins in solutions.*

# Table of Contents

|                   |  |     |
|-------------------|--|-----|
| <b>Foreword</b>   |  |     |
| <b>Chapter 1</b>  | Introduction   | 1   |
| <b>Chapter 2</b>  | Summary Discussion for Conservators                  | 5   |
| <b>Chapter 3</b>  | Chemistry  | 13  |
|                   | The Epoxy Component                                  | 13  |
|                   | The Amine Curing Agent                               | 17  |
| <b>Chapter 4</b>  | Resin Properties and Consolidation Problems          | 21  |
|                   | Penetration  | 21  |
|                   | Stone Characteristics                                | 21  |
|                   | Polymer Migration                                    | 24  |
|                   | Color Formation                                      | 28  |
|                   | Resistance to Biodegradation                         | 32  |
| <b>Chapter 5</b>  | Nonsolvent Systems                                   | 35  |
|                   | Low-Viscosity Formulations                           | 35  |
|                   | Application of Epoxy Resins at Elevated Temperatures | 37  |
| <b>Chapter 6</b>  | Comparison of Epoxy Resins with Other Consolidants   | 39  |
| <b>Chapter 7</b>  | Aliphatic Epoxy Resins                               | 49  |
| <b>Chapter 8</b>  | Solvent Effects in Resin Application                 | 57  |
| <b>Chapter 9</b>  | Application Procedures                               | 69  |
|                   | Pocket Methods                                       | 69  |
|                   | Bulk Procedures                                      | 73  |
| <b>Chapter 10</b> | Field Results  | 77  |
|                   | Work in Poland                                       | 77  |
|                   | Work in the United States                            | 79  |
|                   | The California Building, San Diego                   | 79  |
|                   | The Crescent Hill Baptist Church, Louisville         | 83  |
|                   | The Cathedral of the Assumption, Louisville          | 83  |
|                   | Work in Italy  | 85  |
| <b>Appendix</b>   |  | 91  |
| <b>References</b> |  | 95  |
| <b>Index</b>      |  | 103 |

# Foreword

The seventh volume of the Getty Conservation Institute's Research in Conservation Series is the first on architectural conservation. Like two of its predecessors, *Cellulose Nitrate in Conservation* and *The Evaluation of Cellulose Ethers for Conservation*, the present work on epoxy resins deals with the materials and methods of the conservator. This discourse combines the detailed chemistry of the materials with practical handling considerations.

In selecting the use of epoxy resins in building stone treatments, we wished to present a balanced review of a much misunderstood class of materials. Perhaps more than any other stone consolidants, epoxy resins are recalled negatively as viscous, nonpenetrating, crust-forming, yellowing systems that, at best, are only useful as structural adhesives. Yet the success of numerous treatments in the United States, Poland, and Italy relegates this reputation to only one class of epoxy resins and not the entire family. For the appropriate problem, epoxies provide the same success as silanes or acrylics, frequently with much higher mechanical strength.

In considering both the more common materials and others such as the aliphatic resins, whose theoretical properties may be superior to the presently applied products, the conservation profession can begin to expand the limited inventory of treatment materials now used. This expansion means, in the long run, more options and hopefully better conservation. Nevertheless, this book does not propose or suggest a wholesale unconsidered use of this class of materials. The literature supports the use of epoxy resins to solve many problems. Many others can be addressed by other consolidants. It is up to the reader to make an informed judgment.

We have presented a family of resins that contribute to an expanded inventory of chemical consolidants. It is our hope that this book stimulates a dialogue on the merits of different techniques of application as well as the effects of the solvents.

The interactions of solvents as penetration promoters and as cure modifiers are particularly significant for epoxy resins. By manipulating these factors, the conservator has tremendous influence over the consolidant once it gets into the stone, perhaps more than any other consolidant system. Thus the old reputation of epoxies is as much a statement about technique as about chemistry. For this reason, the final chapter on "Field Results" provides valuable insights into successful applications. We will be delighted to hear from readers their thoughts on the present publication.

*Miguel Angel Corzo*  
*Director*  
*The Getty Conservation Institute*



# Acknowledgments

This monograph has benefited greatly from information, review and assistance provided by numerous people. Special acknowledgments go to Dr. K. Lal Gauri of the University of Louisville who supplied me with a treasury of unpublished reports and photographs and to Dr. Petr Kotlik of the Prague Institute of Chemical Technology who also sent many pictures and wrote long letters in English describing his research on epoxy resins in stone. Special thanks to Dr. Marcel Gashke of Ciba-Geigy for data on commercial epoxy resins and to Dr. Ronald Bauer of the Shell Chemical Company for information on aliphatic epoxy resins. Dr. Robert Koestler kindly reviewed the section on biodegradation. Dr. Raffaella Rossi-Manaresi graciously supplied information on studies where she examined epoxy resins. Dr. Lorenzo Lazzarini provided descriptions of field projects where STAC resins were employed. Dr. Ewa Derkowska supplied translations of several articles by Wieslaw Domaslowski. The discussion on saving Pier 187 in Los Angeles was made possible by data supplied by Mr. George Horeczko of the Engineering Division of the Port of Los Angeles.

The author appreciates the helpful reviews provided by Dr. Frank Preusser and Dr. George Wheeler and is especially grateful to Dr. William Ginell who, critically but constructively, went over every sentence. My thanks go to Nancy Tyner for bibliographic searches and Marlene Wholihan, who with great tenacity and creativity, tracked down and obtained every obscure reference. Karen Sexton-Josephs typed the many drafts with much patience, skill, and good humor. I want to thank Irina Averkieff for the many hours she spent turning a rough draft into a polished monograph, as well as Ann Zumwinkle for her expert redrawing of the figures and graphs on computer.

## The Author

Dr. Charles Selwitz received his Ph.D. in organic chemistry at the University of Cincinnati in 1953. After graduation, he was with the Gulf Research and Development Company in Harmorville, Pennsylvania until 1982 where he was Director of Synthetic Chemistry. During that period he published 121 papers and patents, mostly in the fields of acetylene chemistry, oil field chemicals, high-performance polymers, and hydrocarbon oxidation. He is now an independent consultant, but works primarily for the Getty Conservation Institute on problems of stone consolidation.

# 1 Introduction

In 1986, the Office of Technology Assessment of the United States government issued a report titled "Technologies for Prehistoric and Historic Preservation" which pointed out that this country has been losing its cultural heritage at an alarming rate. The thrust of the OTA report was to suggest the use of modern technologies as the most cost-effective way of dealing with this problem. In the past 25 years, conservators in many countries have turned to new forms of synthetic polymers for the preservation of failing artifacts and as a means of dealing with environmentally caused deterioration of sandstone, limestone, marble, and other building stones that are a critical part of the fabric of many historic structures.

There is some controversy about putting polymers into stone to provide stabilization. How can any organic material make inorganic rock stronger? There is, in fact, ample evidence that epoxy resins injected into cracked, crumbling, concrete wharfs, bridges, and buildings can rehabilitate these structures to provide many additional years of service. In November 1989, Pier 187 of the Port of Los Angeles was inspected. This structure was built in 1920, but by 1957 it had deteriorated, and the concrete beams had large transverse cracks of up to 1 cm in width (Wakeman et al. 1962). The pier was going to be torn down and rebuilt. Instead, it was injected with epoxy resin; 2700 kg (6000 lbs) were pumped into 1500 m (5000 linear feet) of cracks. Afterward, the sections that were inspected appeared sound and stable and looked as if they could last another 30 years (Fig. 1). The application of pressure-injected neat epoxy resin has been used on numerous public, commercial, and historic structures around the world, almost since the time the material was first made available in the 1950s. Many projects concerned with the preservation of cultural property can be cited. The list would include the 500-year-old Church of Santa Maria Maggiore in Venice (*Corrosion Prevention and Control* 1974); the 700-year-old Dom Cathedral in Utrecht; the St. Coeur de Marie Church in Quebec City; the National Palace in Managua; the Santa Domingo Church in Guatemala City; the arch columns of the Mission San Juan Bautista in California (Adhesive Engineering Company 1980); Borobudur, the giant stepped pyramid that is the world's largest Buddhist monument where 227 metric tons (250 tons) of epoxy resin were used (*Aspect* 1983); and Westminster Hall, Kew Palace, and the Tower of London (*Stone Industry* 1984). So, the question of the durability, adhesion, and strength-imparting properties of epoxy resins and the appropriateness of using this organic polymer in stone appears to have been answered.

One of the reasons that epoxy resins are usually the materials of choice for repairing cracks in stone, mortar, and masonry is that although they are viscous systems they penetrate effectively into porous substrates in a way that provides an embedded network into the material (Crosby 1980). It has been shown that when an epoxy resin and a methyl methacrylate-prepolymer mixture of the same viscosity (150 cP) were used to treat failed concrete, the epoxy system was more effective in filling the pores (Blankenhorn and Kline 1977). The



*Figure 1. Epoxy repairs at Pier 187, Port of Los Angeles, thirty-six years after application. 1989.*

strengthening and conservation of the stone itself, as it becomes more porous and fragile with time, however, is substantially another problem. Chemicals are used to strengthen and protect weathered stone against further deterioration by a process known to conservators and conservation scientists as consolidation. The polymers or polymer precursors, typically are brought into the fragile, often highly porous stone as relatively dilute solutions in an organic solvent. The solvent is used to achieve a formulation of low viscosity that enables deep penetration to occur. Ideally, after the solvent evaporates, the consolidant penetrates deeply enough to reach undeteriorated stone and remains as a thin layer, suitably polymerized and bonded to the internal surfaces and between the stone particles. The product can be viewed as a porous "composite"

between the epoxy resin and the stone matrix, with the attendant properties and advantages of this relationship. The composite greatly improves mechanical strength. The consolidation should allow water to pass through the stone while it is protected against attack by water or chemicals.

In contrast to the generally effective use of neat epoxy resins as injected cements, the application of resins in the special solvent formulations required for consolidation has been much less successful. The major difference between the two systems is the involvement of solvents. In fact, as will be shown, the lack of understanding of the role and behavior of organic solvents is the reason that poor results were obtained by a large number of conservators who compared epoxy resins with other consolidants. When the role of solvents is adequately researched and understood, much better results will be obtained.

The practical development of epoxy resins began in the late 1930s. By the 1950s, these resins were widely used commercially. Their earliest application for art conservation and in solution formulations for the consolidation of porous materials was reported in the early 1960s in a number of popular articles on the use of various Araldites, which is a trade name for Ciba-Geigy epoxy resins. Domaslowski, by the late 1960s, and Gauri in the early 1970s, had published extensively on the developmental research and field application of procedures for the successful consolidation of deteriorating stone. Judging from the later unsuccessful or inconclusive work of many other investigators, it appears that these two preservationists were several years ahead of their time. Their programs, however, moved in different directions. Domaslowski's research at Nicholas Copernicus University in Poland on the properties of epoxy resin solutions was used to develop procedures suitable for the stabilization of statuary and localized problems in outdoor structures, while the studies of Gauri at the University of Louisville in the United States on the protection of marble and limestone against attack by sulfur dioxide became the basis for restoring and protecting large surface areas of buildings and monuments.

## 2 Summary Discussion for Conservators

This chapter uses terms and references from the conservation literature, but subsequent sections emphasize technical terminology and methods relating to the use of epoxy resin as consolidants of stone. For example, proper chemical names are generally used throughout, rather than trade names or company designations, so that relationships between structure and properties can be followed more easily. Considerable attention is given to structural chemistry, reaction mechanisms, theories of penetration, properties of solutions, and other technical aspects of this topic. However, this is a book for conservators, not polymer chemists, and in this chapter the focus is on those factors of interest and importance to conservators. Here, they will find most of what they need to know about problems, opportunities, and general methodology, and they can look upon the rest of the book as an appendix to be used when additional information and more detailed explanations are required. **Please note that chemical structures, equations, tables, and references have been deferred to later chapters.**

Conservators are generally familiar with the use of epoxies as two-part systems. The resin, taken from a tube or a can, is mixed with a carefully measured quantity of hardener from a similar container, and the product is applied as a neat system by squeezing or daubing in an area where a strong adhesive is needed. In a similar manner, conservators, primarily in the United States and Italy, have used epoxy resins successfully to stabilize building stone. The conservator, working with a contractor, may have the responsibility for accurately weighing pail-sized quantities of resin and hardener and supervising the blending of these components, by workmen, into barrels of solvent. The solution is applied to the surface of the stone by brushing or spraying, or by using other more complicated application procedures. The subject of this monograph is the developmental research by conservators that has come after the simple mixing of two components.

From as early as the 1960s, when the use of polymers for the consolidation of decaying stone came into vogue, epoxy resins were candidates of high interest because of their durability, good adhesion, and exceptional mechanical strength. In many studies published in the conservation literature comparing different classes of consolidants, epoxy resins were found to yield the strongest products. The various types of consolidants were usually applied according to the directions supplied by the manufacturer. However, it soon became apparent that there were disadvantages as well as advantages to the use of the epoxy resins. The manufacturers' directions generally led to liquids that were far too viscous for satisfactory penetration into stone. The high concentration of resin near the surface inevitably left a crust and caused color problems. Clifton, for example, compared a variety of consolidants and found epoxy resins to be best for consolidating sandstone and limestone powder into a strong monolith and for harden-

ing limestone against erosion caused by dripping water saturated with carbon dioxide. However, he showed that this resin was unable to penetrate a limestone block, whereas an alkoxy silane and an acrylic solution passed through easily. Rossi-Manaresi tested neat epoxy resins along with silane esters, acrylics, and other consolidants on buildings clad with yellow Bolognese sandstone. Her initial evaluation indicated that the epoxies did not penetrate well and caused darkening and other color problems. The resin solidified near the surface to form a crust that looked like it would split off. Seven years later, however, the epoxies seem to have provided the best stabilization among the various consolidants that were tried, although the stone was still discolored and appeared about to cleave. During the 1970s, several buildings in the United States and Europe were treated with epoxies without an adequate understanding of the viscosity-penetration problem, and the ensuing crust formation and severe discoloration gave epoxy resins a bad reputation as stone consolidants.

Solving the viscosity problem seemed to be the answer to overcoming poor penetration, crust formation, and discoloration. Moncrieff and Hempel worked around this obstacle by using Marasett resins and carrying out the consolidation at 70 °C. Preliminary studies were done on pieces of weathered marble and then on several small outdoor objects at the Victoria and Albert Museum. A thermally insulated containment tent was built around the object and ramped up to temperature with electric heaters over several days. It was necessary to use protective sheets of polyester to prevent oxidation of the resin. Working in a confined, hot, fume-filled space was difficult, dangerous, and very unpleasant. Nevertheless, in 1977, Moncrieff and Hempel went on to apply their findings to the consolidation of a statue by Pyrgotelis, the *Virgin and Child*, on the facade of the Church of Santa Maria dei Miracoli in Venice. An inspection after four years found that the deterioration had stopped. The authors claimed that the epoxy resin imparted little or no color to the treated stone.

The problems of operating at high temperatures are formidable and have discouraged conservators from working with stone in this manner. A different approach was advocated by Munnikendam who developed low-viscosity consolidant formulations by blending components that individually had low viscosities. Munnikendam was against the use of solvents because he felt they limited the amount of consolidant provided during application and because evaporating solvent might draw the resin to the surface where it would concentrate. His formulation consisted typically of a low-viscosity amine hardener and a diepoxide compound based on a small four-carbon-glycol, and it used ethyl silicate as a reactive diluent. The blended components had a resultant viscosity comparable to water. While laboratory studies showed this mixture to have promise, field studies indicated that the formulation provided poor penetration and left a discolored crust at the surface. A number of researchers working with resins based on butanediol have found that the cured resins are susceptible to hydrolysis and do not stand up in corrosive atmospheres. Following the solventless approach, Proudfoot achieved somewhat bet-

ter results on Pakistani Gandharan sculpture with more conventional epoxy resins and Dow Corning Silane Z 6070 (methyl trimethoxysilane).

The "conventional," i.e., the most extensively used type of epoxy resin is a large aromatic compound, the diglycidyl ether of bisphenol A (Chapter 3, "Chemistry"). These resins are more familiar as members of epoxy product lines such as the Araldites produced by the Ciba-Geigy Corporation or the Epons of the Shell Chemical Company. In Poland, these resins are called Epidians and in Czechoslovakia, they are designated as CHS. This class of epoxy compounds is manufactured and available worldwide as a range of condensation products with a corresponding range of molecular weights and viscosities. The largest volume products, such as Araldite 6010 or Epon 828, contain mostly monomer with a small amount of condensation product. The aromatic nature of the compound confers a molecular rigidity that results in increased resin viscosity. The transformation of the aromatic structure to an aliphatic derivative by hydrogenation yields a product with much lower viscosity. It also provides a resin that is less likely to discolor. This product is offered in the United States by Shell under the trade name Eponex. However, there are no references to the use of this product in the conservation literature. In Italy, a cycloaliphatic epoxy resin, EP 2101, offered by the Milanese company, STAC, has found increasing use in field application for stone problems in Italy and has been recommended by preservationists such as Lazzarini.

A cured resin is obtained after a hardener or curing agent is mixed thoroughly with the epoxy compound. The hardener is an amine that unleashes the reactivity of the epoxy groups to form linear and cross-linked chains. Additionally, the amine is to a large extent responsible for the good adhesion of the polymer, but may be the primary cause of discoloration. For many years, the principal hardeners were small cyclic or linear aliphatic compounds with a high content of amine functionality. Some members of the most widely used group are polyamines described in the literature as DETA (diethylenetriamine) or TETA (triethylenetetramine). These compounds provide rapid curing at room temperature, but they can also lead to highly colored products. They also tend to be volatile, physically irritating, and toxic. Their low molecular weight creates a problem in the field when workers are required to measure precise amounts to go with the much larger epoxy portions. Because of these drawbacks, modified amines that are less volatile and toxic and give more stable products have been finding favor. The amine hardener HY 956, offered by Ciba-Geigy, at one time was triethylenetetramine but today HY 956 is an alkoxyated triethylenetetramine. This is an example of modification by the preparation of a derivative of the basic polyamine. Another example is the reaction product of polyamine with a fatty or dimer acid, which is known as an amidoamine. Typical commercial hardeners using dimer acids are General Mills' Versamid 125 and HY 825 from Ciba-Geigy. In a somewhat different approach, stabilized curing agents have been made by separately mixing the polyamine with a limited amount of the epoxy resin or with an aliphatic polyether. Particu-

larly favored outside of the conservation community for their low viscosity and the outstanding light stability of their resins are the amine derivatives of polypropylene ethers such as Jeffamine D-230 or T-405 from the Texaco Chemical Company. All of these derivatives, however, provide slower curing rates than the simple polyamines. While many industrial applications of epoxy resins require the use of a variety of additives such as reactive diluents, plasticizers, accelerators, and other modifiers, stone applications generally involve only an epoxy compound, a hardener, and a solvent.

Stone conservators who have worked with epoxy compounds for field problems have gone in two directions, either solving the problems attending the use of aromatic bisphenol A derivatives or attempting to develop superior aliphatic resins. In the older, more conventional approach, conservation scientists such as Gauri, Kotlik, and Domaslowski have used bisphenol A-derived epoxides and basic polyamines, such as DETA or TETA, primarily because of cost and availability. These workers have performed the developmental research necessary to work through problems associated with aromatic resins and then treated statuary and buildings with excellent results. Consider the color problem long associated with the use of epoxy resins in this application. While horror stories abound, preservationists who have worked successfully with these compounds insist that poor results are due to inappropriate application techniques. They have shown that procedures must be used that carry the consolidant deeply and evenly into the stone and do not leave a high resin concentration at the surface. In some cases, it has been recommended that resin remaining at the surface be removed by wiping with solvent or using very gentle abrasion, although conservators generally find this latter procedure unacceptable. In any event, the light-catalyzed oxidative deterioration of cured resin, which is the cause of chalking and yellowing, is likely, in time, to remove polymer and color from exposed surfaces. Conservators planning to use these resins for stone work should demonstrate that there will not be a color problem with the use of a chosen resin by doing a little experimentation. A small piece of stone should be immersed in a solution of resin monomers, wrapped lightly with plastic film after retrieval, allowed to cure for about one week, unwrapped, and finally wiped on one surface with solvent. If that surface then displays unsatisfactory discoloration, the consolidation should not be attempted.

Obtaining satisfactory penetration by the resin solution has been more of a problem than discoloration and has required much more study. Depth of penetration depends on the nature of the stone, the composition and viscosity of the consolidation system, and the way in which the consolidating solution is put on and maintained in contact with the stone surface.

To choose a proper resin and solvent system and to select a suitable method of application, some understanding of the characteristics of the stone and the geometry of its deterioration is important. Marble and low-porosity limestones that have degraded by shallow surface erosion will probably not be amenable to consolidation with epoxy resins and may be



protected more effectively by treatment with a water repellent. Porous tuffs or cast, synthetic stones are likely to be excellent candidates for epoxy treatment, possibly even by spraying, while success with sandstones or porous limestones is probably achievable, but only after careful design and testing of procedures. Some conservators have set lower porosity limits for successful treatment of sandstone and limestone. For example, Domaslawski has suggested limits of 14% porosity for sandstone and 28% porosity for limestone. These minima refer to fresh stone and not to the deteriorated material that is usually the candidate for treatment. Studies on marble that was highly deteriorated after 100 years of exposure showed that over 50% of the marble in the outer zone was gone and higher porosity was created. While treatment of fresh stone with a solution of resin did not improve the compressive strength, the much weaker, weathered stone took up resin and the mechanical properties were improved substantially. The porosity created during deterioration is an important factor in facilitating penetration. The chemical composition of the stone will determine the activity or polarity of the surface, and this is another factor that can affect penetration. Capillary rise of epoxy resin solutions can be from one to two orders of magnitude slower in limestone than in sandstone of comparable porosity. This helps explain why sandstones are generally more easily stabilized than limestones. The effectiveness of consolidation will be sharply diminished if the substrate contains salts. These must be removed. The discussion of field projects in Chapter 10, "Field Results," provides details on how various workers have addressed this problem.

The nature of the solvent does not play a critical role in defining the viscosity of the uncured resin solution except to the extent that its chemical type affects the rate of polymerization. The resin components, the epoxy compound, and the curing agent are monomers before they are combined with solvent, and the initially formed solutions have relatively low viscosities even at resin concentrations as high as 20 to 30%. Of course, it helps to use monomers that are at the lower end of the molecular weight spectrum. For example, in the bisphenol A line of resins produced by the Rhone Poulenc Chemical Company, Epi-Rez 509, which has a viscosity of 7000-10,000 cP, would be favored over Epi-Rez 510 or Epi-Rez 515, which have much higher viscosities. Epi-Cure 874, an amidoamine containing accelerators, or Epi-Cure 832, a cycloaliphatic derivative, which have viscosities in the 100 cP range, might be favored curing agents.

Brushing is a suitable application procedure for some types of stone. However, for many types of low-porosity stone, this method does not provide adequate penetration. Studies have shown that if a volume of liquid, rather than the thin film provided by brushing, can be maintained against a surface, very substantial penetration will result. For example, when Domaslawski treated historic sandstone lintels, overlapping rows of pockets made of fortified paper were glued to the stone surface and filled with epoxy solution. As long as there was uptake by the stone, the pockets were kept filled. The pockets were then removed and the surfaces were cleaned and wrapped for up to 40 days. This was a cumbersome and not very popular

procedure. Nevertheless, large amounts of consolidant penetrated in to 7.5 to 10 cms, a depth not often achieved in stone treatment.

The disadvantages led Domaslowski and his coworkers to the development of a solution recycle system as a more efficient way of consolidating larger objects. For the treatment of the statue of St. Francis in Klodke, Poland, the structure was covered with vertical strips of cellulose wadding and then tightly wrapped in polyethylene film. It was necessary to construct a strong frame to hold the wadding and insure that the wrapping was leakproof. The upper end of each strip was immersed in resin solution and served as a wick. Solution passed into the strip and down against the stone surface as a liquid column. Material collected at the base was pumped back up to the elevated receptacles that fed the wicks and the solution was recycled over a 5 1/2-hour period. Deep penetration was achieved and the statue was stabilized. Wrapping treated stone with plastic film causes the consolidating solution to remain in place while the polymer forms and precipitates onto the surfaces within the stone. If this is not done, the solution will diffuse back to the surface and solvent evaporation will result in formation of a crustal layer and surface darkening. Wrapping will also encourage the solution to migrate deeper into the stone and provide greater penetration.

It is interesting to note how differently the technology of treating stone with epoxy resins has evolved in Europe and the United States. In Europe, the teachings of Domaslowski on using blends of alcohols and aromatic hydrocarbons as the solvent for the resin and maintaining contact of the consolidating solution against the stone surface have been followed by many stone conservators. This work has been extended and modified both by Kotlik and Lazzarini who have used similar solvents and application procedures. Like Domaslowski, they have carried out their interventions on limestone statues and on relatively small but important stone sections of buildings and monuments. In contrast, in the United States, stone consolidation with epoxy resins has been carried out only by one person, Gauri, who has focused on major building renovations where large areas of stone had to be treated. Spraying has been his primary method of application, perhaps because of the scale of the operation, and acetone was used exclusively as the solvent. In many cases, the faltering building material was porous cast stone or deteriorated natural stone where good penetration was easily attained. It is not achieved in low-porosity substrates such as Indiana limestone, but the limited impregnation that does occur in these cases was judged by Gauri to be sufficient to provide the necessary stabilization. Discoloration was eliminated by using a mild abrasion on the treated surfaces. Although Gauri is satisfied with his procedures and results, other preservationists do not entirely agree with his methods. From the limited number of field projects that have had success with epoxy resins as the main consolidant, two schools of treatment have emerged. The European approach has been used on about a dozen problems in Poland, Czechoslovakia, and Italy over the last 20 years, while the American school is exemplified by Gauri's program over the same time span when

four major buildings and small sections of many other structures were stabilized with these materials.

Gauri's experience should be instructive to workers faced with saving the fabric of a building that has large areas of deteriorated stone. Projects of this scope must be done in collaboration with a general contractor and an architect and must include an assessment of the nature of the stone and the degree and causes of deterioration, and an evaluation of consolidants, cleaning, desalinization, and treatment. It is important to establish performance criteria based on realistic needs and to monitor compliance by contractors.

Salts must be removed prior to treatment to avoid future deterioration. Typically this was done by the careful application of high-pressure steam followed by cold water. In areas of the stone surfaces where there was no deterioration, the concentration of sodium was about 0.02%. This was selected as the acceptable level of salt in an early project carried out by Gauri, the restoration of the California Building in San Diego, California. Other specifications for treatment required that the stone be impregnated to a depth of 2.5 cm, that the compressive strength of the treated stone be increased by at least 50% over untreated stone, that water vapor permeability be lowered no more than 10%, and that liquid water absorption be no more than 5% after 48 hours. The formulations used in treating the California Building were derived from preliminary studies that demonstrated these goals could be achieved by spraying with 10 and 20% solutions of conventional commercial epoxy resins (Epi-Rez 510 and Epi-Cure 876) in acetone.

For the treatment of smaller, more valuable stone artifacts the European approach is likely to be more suitable. Cycloaliphatic epoxy resins such as Shell's Eponex or STAC's EP 2101, in particular, should be evaluated as consolidants. In the treatment of the plinth of the statue on the left side of the lateral portal in the Santa Maria Maggiore Church in Trent, Italy the stone was placed in a solution of 24% EP 2101 and 5% aliphatic polyamine hardener in an isopropanol and toluene blend in a waterproof plastic film container. This was immersed in water, which produced useful hydrostatic pressure. When the solution turned to gel, the plinth was removed and the gel was brushed away to leave well-consolidated stone. In other situations, the necessity for further cleaning would depend on the type of stone and the nature and quality of the ingredients in the consolidating solution. This procedure, developed by Lazzarini, is a generally useful method for the stabilization of objects that are not too large in size. Figure 2 illustrates how this can be done. A wood box, built to contain the object, is draped with two sheets of 3 mil polyethylene film. The artifact is placed on the upper sheet. Resin solution is poured into this containment and the upper sheet is pulled up and gathered. The space between the outer and lower sheets of polyethylene is then filled with water to a level above the object. After the amount of resin solution is adjusted so that a minimum volume covers the object, the containment formed by the upper sheet is sealed at the gathering point. In time, gel formation occurs and the object can be removed and cleaned.

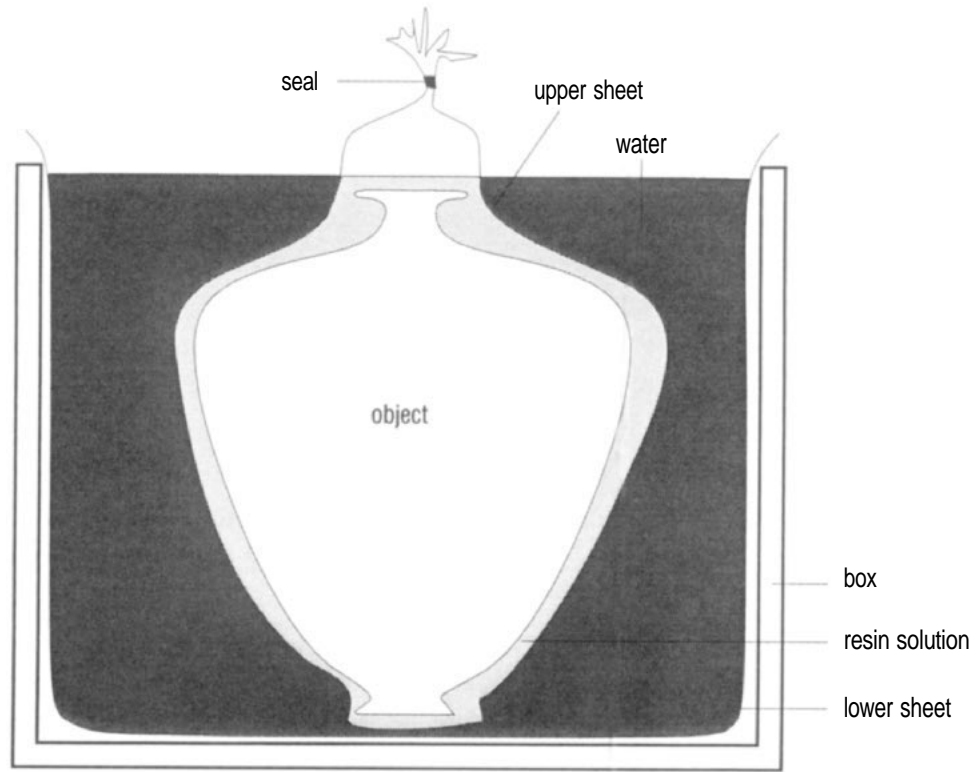
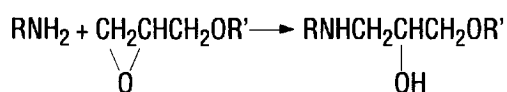

Figure 2. Scheme for consolidating stone with epoxy resins using the containment method.

# 3 Chemistry

Epoxy resins are polymer-forming systems containing two principal components that interact to produce highly cross-linked products with exceptional toughness, adhesion, and chemical resistance. The key player in the polymerization is epoxy functionality—a strained, three-membered ring consisting of one oxygen and two carbon atoms. This is also known as an oxirane group. This structure reacts with active hydrogen compounds that add to the ring to open it and yield a secondary hydroxyl compound. When the active hydrogen compound is a primary amine, the product contains both a secondary hydroxyl group and a secondary amine (Equation 1). The hydroxyl group is not sufficiently reactive to engage the epoxy group, but the secondary amine is only moderately less active than the primary amine (Shechter et al. 1956). It can react with an oxirane group to provide polymer formation with polyfunctional epoxy monomers (Equation 2).

Equation 1.



Equation 2.

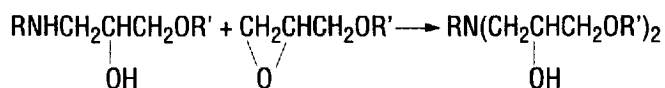

Polymerization occurs without the formation of condensation by-products or off gases and generally with less than 5% bulk shrinkage. Preferably the active hydrogen compound should contain several primary and secondary amines. The high reactivity of appropriate amines enables the resin to cure at relatively low temperatures, i.e., at or near ambient. The product will have a large proportion of nitrogen and oxygen heterofunctionality. Many strong adhesives, such as cyanoacrylate and isocyanate-derived polymers, cellulose nitrate, and animal gelatins derive their desirable bonding properties from the intramolecular presence of both oxygen and nitrogen. Mechanical hooking and covalent bonding each play a role in epoxy polymers that function as adhesives, but the major mechanism for adhesion is the sharing of electrons between the polymer and the substrate, i.e., coordinate bonding. The availability of both nitrogen and oxygen atoms provides the variety of spatial and electronic configurations needed to match more of the diverse receptor configurations of the substrate.

## The Epoxy Component

Cured resins with widely differing properties can be obtained by changing the structure of the epoxy compound. Industrial chemists have succeeded in synthesizing and making commer-



Equation 4.

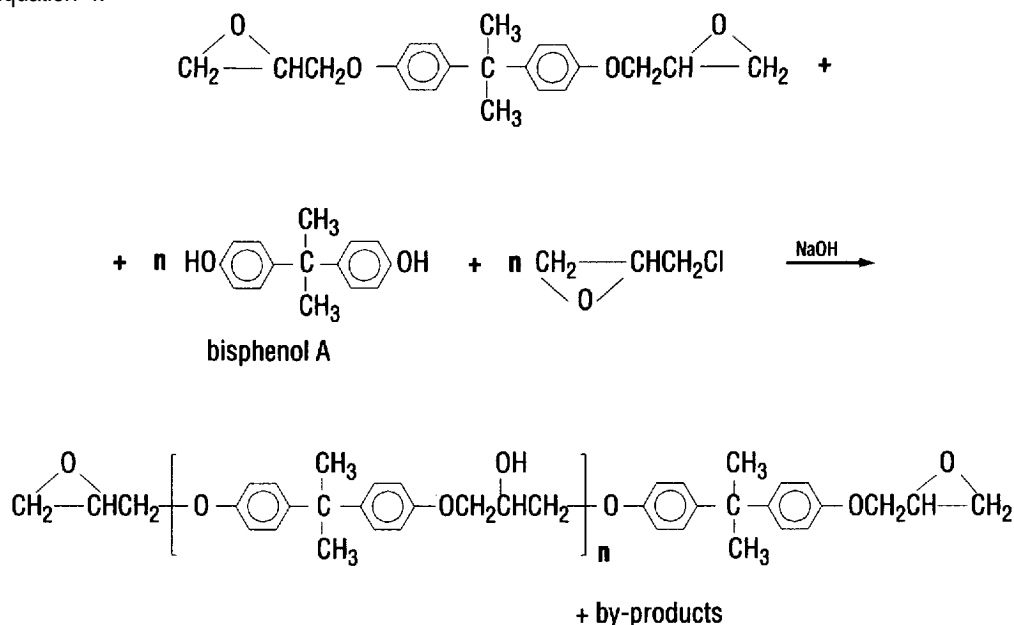

As  $n$  increases, the resin becomes more viscous, and when  $n$  is 2 or more the product is solid. The largest volume and most important product commercially is a mixture made up primarily of pure bisphenol A diglycidyl ether and much smaller amounts of oligomers. The composition consists of 87-88% diglycidyl ether with  $n = 0$ , 11% with  $n = 1$ , and 1-2% with  $n = 2$ . This provides a resin with an average molecular weight of about 370, which is prepared by using a very high ratio of epichlorohydrin to bisphenol A to minimize Equation 4. Products obtained in this manner have epoxy equivalent weights of 180-200 and viscosities at 25 °C of 10,000-18,000 cP. Typical examples of this material are Araldite 6010 (Ciba-Geigy) and Epon 828 (Shell). Resins such as Epon 825, which are essentially free of oligomers, have much lower viscosities, 4000-5500 cP at 25 °C. Most countries with a basic chemical industry produce a range of epoxy resins derived from bisphenol A. In Poland, these are known as the Epidian series, which range from Epidian 1, a solid bisphenol A diglycidyl ether with a value of 0.16-0.20 equivalents of epoxy group per 100 grams, to Epidian 5, which is a liquid epoxy resin with an average molecular weight close to 370.

Promising resins for stone consolidation are produced commercially from bisphenol A by hydrogenation to 2,2-di(4-hydroxycyclohexyl) propane and reaction of this compound with epichlorohydrin (Equations 5-6).

Equation 5.

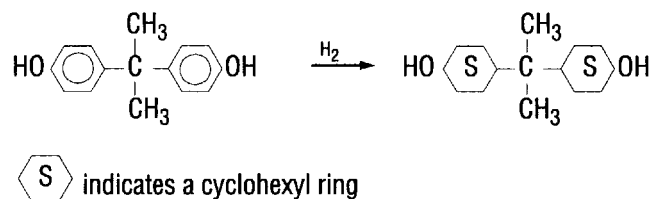

Equation 6.

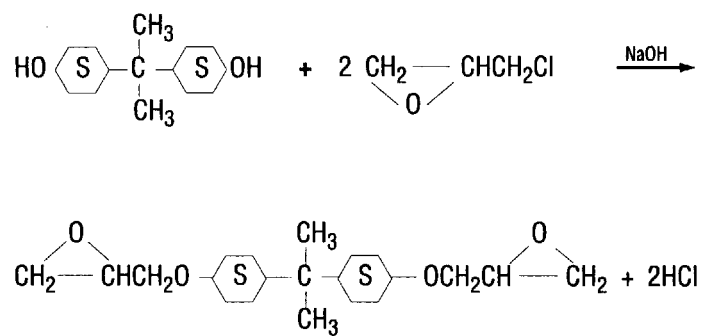

The resulting cycloaliphatic molecule is bulkier and less linear than bisphenol A glycidyl ethers. This and the conversion of rigid benzenoid structures to molecularly flexible cyclohexyl rings provides products such as Shell's Eponex resins with sharply lower viscosities (Table 6) and better light stability than their aromatic counterparts. The use of diglycidyl ethers of relatively small aliphatic glycols, such as 1,4-butanediol, to produce epoxies that have low solution viscosities, has not worked well. Kotlik (1990) found that a resin based on butanediol diglycidyl ether, even after curing, showed a strong tendency to absorb water in a manner typical of polyols like glycerin. A sample of sandstone impregnated with this resin was destroyed by immersion in water due to the swelling of the consolidant. The interaction of water with relatively nonhydrophobic resins can cause absorption and plasticization, lowering of glass transition temperature, and disruption of bonding in the interfacial region between stone and polymer. Epoxy resins with relatively high ratios of oxygen to carbon-hydrogen structure can absorb considerable amounts of water. Additional factors affecting the amount and rate of absorption are hardener composition, temperature, and humidity (Shaw 1988).

It is not surprising that Gauri (1973, 1974) found that marble, when coated with an aliphatic epoxy resin (unidentified but stated to have a "chemical kinship" to butanediol diglycidyl ether), was exposed to air containing 0.3% sulfur dioxide at 60-80% relative humidity, it was attacked five times as fast as untreated marble. The role of water was clearly delineated in these studies. There was total deterioration of specimens that had picked up excessive moisture.



Scanning electron microprobe (SEM) analysis showed that the cured aliphatic film on the marble surfaces had an extensive network of pores. The porous, water-absorbing polymer film acted as a sponge to hold the highly acidic and destructive solution of sulfur oxide acids against the calcium carbonate surface. Resins based on bisphenol A do not take up sulfur dioxide and do provide protection for calcitic stone in the acidic environment of these experiments. Aliphatic epoxies do not inherently offer less protection against sulfur dioxide than aromatic structures. What is critical is having a sufficiently high ratio of carbon-hydrogen structure to heterofunctionality to provide hydrophobicity. Butanediol does not have this character. Aliphatic epoxy resin based on hydrogenated bisphenol A or fluoroalkyl compounds should deter corrosive attack by sulfur dioxide and not have this problem. An additional factor that affects the barrier properties of the consolidant film is whether the film is created from resin solution as solvent evaporates or is deposited by precipitation. The former case has been shown to result in cracks in the protective layer as volume contraction due to cross-linking takes place (Kotlik et al. 1981).

## The Amine Curing Agent

Although epoxy resins can be polymerized catalytically, the products are very brittle, and curing or hardening agents, employed in stoichiometric ratios, are almost always used. The curing agents most commonly cited for use with epoxy resins for stone consolidation are simple polyamines, specifically amino(polyethyleneamine)s such as diethylenetriamine and triethylenetetramine (Table 1a and b), and unidentified aromatic and cycloaliphatic amines. The nature of the amine is a major factor in the rate of curing and in the resistance of the cured resin to yellowing and discoloration. The time it takes for the resin to cure can play a role in determining the depth of penetration achieved by the consolidant. Amino(polyethyleneamine)s provide curing at a very desirable rate at low ambient temperatures, but they can also lead to discolored products. Because of their low vapor pressure these amines can be physiologically irritating and awkward to work with, and the toxicity of these compounds has restricted their availability in many countries. Despite these drawbacks, these amines are still being used occasionally, but more often, in their stead, modified, less volatile and less toxic polyamines, such as epoxy adducts and amidoamines, are finding favor. Aminopoly(ethyleneamine)-epoxy adducts are premixed blends of epoxy resin with excess polyamine. Amidoamines are reaction products of higher fatty acids with aminopoly(ethyleneamine)s.

One widely used class of amidoamines, Versamids, is made by heating an aminopoly(ethyleneamine) mixture with a dimerized eighteen-carbon fatty acid (Table 1c). A primary amine at one end of the aminopoly(ethyleneamine) chain reacts with a carboxyl group to form an amide, and the remaining unreacted amino groups provide for epoxide curing. In general, these modifications have led to slower cure rates but have given products that are more

resistant to color formation. To overcome the decrease in reaction rate resulting from the use of attenuated polyamines, the systems are often catalyzed with tertiary amines, such as tris(dimethylaminomethyl)phenol (Table 1d) or 2-methyl-4-ethylimidazol. It does not appear that these modified amines have been embraced by the preservationists working with epoxy resins for stone stabilization. Domaslawski (1969) compared an unidentified Versamid with triethylenetetramine for hardening an epoxy resin. In this study, the rate of curing of a bisphenol A diglycidyl ether in a toluene-methanol solution was determined by measuring the time required for the appearance of a precipitate. The weight ratio of the diglycidyl ether to triethylenetetramine was 6:1, while the epoxy Versamid ratio was 2:1. Domaslawski found that precipitation of cured resin with Versamid took 50 to 100% longer than with unmodified amine. As a result, he proceeded to carry out all of his work in the laboratory and on monuments in the field with aminopoly(ethyleneamine)s. But the toxicity and restricted availability of these compounds signals an important need for more information on the use of modified amines for stone consolidation.

The aminopoly(ethyleneamine)s have two exposed, active primary amine groups and will react with atmospheric carbon dioxide to form undesirable solid amine carbonates. This can be avoided by many of the same stratagems used to diminish color formation—for example, by mixing the aminopoly(ethyleneamine)s and the polyglycidyl compound in solvent and allowing the solution to stand for an induction period of about an hour before application. Primary amines react more readily with oxiranes than secondary amines, and the product shows much less tendency to form carbonates. Similarly, amine curing agents containing only secondary amines or primary amines that are sterically hindered or are not on terminal positions will show less tendency to form amine carbonates. A number of workers in this field have mentioned the use of cycloaliphatic amines of undisclosed structure that would have these characteristics (Marinelli 1975, Cavaletti et al. 1985). Menthane diamine (Table 1e) and isophorene diamine (Table 1f) are known examples. The most attractive curing agents at this time may be the Jeffamine series of aminopoly(oxypropylamine)s that are often used as curing agents for epoxy resins destined for glass repair. The smallest member of this series is a dimeric diamine, Jeffamine D-230 (Table 1g), which has a molecular weight of 230 and a viscosity of only 10 cP at 20 °C. Jeffamine T-403 (Table 1h), the next product in this family, is a triamine. These hardeners can provide resins that show no discoloration.

|  |   |             |
|--|---|-------------|
| a. Diethylenetriamine                    | $\text{H}_2\text{N}-(\text{CH}_2)_2-\text{NH}-(\text{CH}_2)_2-\text{NH}_2$  |             |
| b. Triethylenetetramine                  | $\text{H}_2\text{N}-(\text{CH}_2-\text{CH}_2-\text{NH})_2-\text{CH}_2-\text{CH}_2-\text{NH}_2$  |             |
| c. Dimer acid used in making amidoamines |   |             |
| d. Tris(dimethylaminomethyl)phenol       |   |             |
| e. Menthane diamine                      |   |             |
| f. Isophorone diamine                    |    |             |
| g. Jeffamine D-230                       | $\text{H}_2\text{N}-\underset{\text{CH}_3}{\text{CH}}-\text{CH}_2-\left[ \text{O}-\text{CH}_2-\underset{\text{CH}_3}{\text{CH}} \right]_x-\text{NH}_2$  | $x=2.6$     |
| h. Jeffamine T-403                       | $\begin{array}{c} \text{CH}_2-\left[ \text{OCH}_2\text{CH}(\text{CH}_3) \right]_x-\text{NH}_2 \\   \\ \text{CH}_3\text{CH}_2\text{C}-\text{CH}_2-\left[ \text{OCH}_2\text{CH}(\text{CH}_3) \right]_y-\text{NH}_2 \\   \\ \text{CH}_2-\left[ \text{OCH}_2\text{CH}(\text{CH}_3) \right]_z-\text{NH}_2 \end{array}$ | $x+y+z=5.3$ |

Table 1. Structures of epoxy resin curing agents.



# 4 Resin Properties and Consolidation Problems

## Penetration

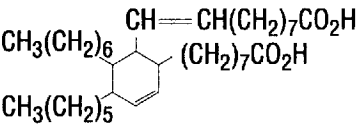
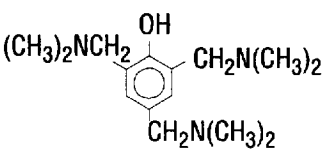
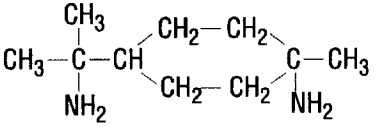
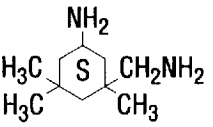
The biggest problem in achieving effective long-term preservation of stone is getting the consolidating resin in place. Achieving deep penetration is a problem with most consolidants, but epoxy resins have an especially poor reputation in this regard. This chapter examines the properties of the stone substrate and the transport characteristics of epoxy formulations that affect penetration, while Chapter 9 ("Application Procedures") describes methods other than brushing that have been used or advocated for treating large surfaces.

## Stone Characteristics

Success in stone consolidation depends upon achieving deep penetration. The depth of penetration is affected by the characteristics of the substrate, such as porosity, pore size, surface polarity, the properties of the consolidating solution, and the manner of application. It is often stated that the preservationist can do nothing about the nature of the stone substrate and thus his attention must be focused on the solution and the means of application. Nonetheless, the porosity parameters and absorption characteristics of the stone must be well defined because they can dictate whether consolidation should be undertaken with the available resources. Also, they influence the formulation of the resin and the choice of application procedures. For many, perhaps most, stone deterioration problems, the application of resin by brushing or spraying is inadequate and other procedures that provide greater duration of contact are required (Kotlik et al. 1983). However, the California Building in San Diego, constructed of porous, cast synthetic stone, is an example of the successful application of an acetone solution of an epoxy resin by spraying (Gauri 1978).

The way in which stone type and porosity influence the likelihood of successful consolidation is illustrated by a study using three very different types of stone: marble, sandstone, and tuff. They were treated with a relatively low-viscosity solution of pentaerythritol tetraglycidyl ether and a cycloaliphatic amine in a mixture of acetone, isopropanol, and water (Alessandrini et al. 1978). The solution was brushed on several times and the samples were wiped immediately with acetone. This procedure is not likely to provide much penetration and, as a result, with either freshly quarried and weathered marble only a thin surface coating was obtained (Table 2). The more porous sandstone showed an average increase in weight of 0.47%, which suggests that this methodology can be used on this material to provide effective consolidation. In the case of very porous weathered tuff, treatment with this resin resulted in a 3.1% increase in weight. This successful impregnation led to the use of resin in the consolidation of tuff in outdoor monuments in Ostia Antica in 1975. Three years later, deterioration was arrested, and the treated zones remained stable.

| Stone                             | Porosity % | Weight Increase % | Penetration, mm     |
|-----------------------------------|------------|-------------------|---------------------|
| Candaglia marble freshly quarried | 1.8        | 0.01              | none (surface film) |
| Candaglia marble weathered        | 1.8        | 0.07              | none (surface film) |
| Arezzo Sandstone                  | 21         | 0.47              | 1.5                 |
| Etruscan tuff weathered           | 45         | 3.11              | 5.0                 |

Resin composition: Pentaerythritol tetraglycidyl ether (Araldite XG40): 25 parts; cycloaliphatic amine (XG41): 8 parts; acetone: 27 parts; isopropanol: 5 parts; water: 13 parts.

Table 2. Effect of stone type on penetration (Alessandrini 1978).

Although void space is critical in providing access for the stabilizing polymer, many studies searching for improved consolidants use unweathered stone. They do not address the importance of porosity, nor the structure of the deteriorated substrates, which are the ultimate candidates for treatment (Ullrich 1971). In most cases, weathered stone has two layers of degradation. Typically, in marble, the outermost layer, comprising about 25% of the weathered zone, is severely deteriorated and is where the largest amount of material has been lost and shows the highest porosity. Between this layer and undeteriorated marble there is a transition area that shows much less deterioration. SEM analysis clearly delineates the outer zone where the cement between granules has been removed and the stronger, deeper layer where destruction of the grain boundaries is beginning. After continuing exposure removes the outer layer, the closest section of the transition layer will lose material and become the new outer layer, and the outermost portions of unaffected stone become the new transition zone. Removing the cement in the outer layer affects the properties in a predictable way. Ullrich measured the specific gravity and compressive strength of a large number of Carrara marble specimens taken from tombstones that were up to 100 years old and were extensively deteriorated.<sup>1</sup> He typically found that at the surface about 56% of the material was removed by weathering. This lowered the surface hardness by 21% and surface compressive strength by 68%. These losses fell to about 1% halfway through the zone of weathered marble.

Using a procedure developed by Gauri in 1970, Ullrich was more successful than Alessandrini in transporting epoxy resin into marble. In his procedure, the stone was sequentially immersed in the following solutions: a 1:1 mixture of acetone in water, acetone with less water, pure acetone, 70% epoxy resin-30% acetone, solutions with increasingly higher concentrations of resin, and finally a bath of 95% resin and 5% acetone. This procedure resulted in low resin in acetone concentrations deep within the stone and high resin concentrations near the surface. Specimens were allowed to cure for several days and then were immersed, first in acetone and then in pure resin. With weathered Carrara marble, penetration of about 1 cm was achieved. The apparent specific gravity was increased by approximately 37% at the surface, but

only 0.4% at a depth of 5 mm. The compressive strength of fresh marble was not increased when treated with resin, but weathered marble with low hardness and strength was improved significantly by this consolidation process. Typically, the compressive strength at the surface was improved by 50 to 60%.

These studies show that success in treating deteriorated stone with epoxy resins depends on consideration of two levels of porosity: the inherent porosity of fresh stone and the nature of the void space created by weathering. A naturally porous stone made fragile and more open by weathering is likely to be a very good candidate for consolidation. An example of how the character of the porosity affects the success of treatment is shown in the results of work on the First Bank of the United States in Philadelphia in 1974 (Gauri 1990). A hard gypsum crust had formed over the marble surfaces in areas sheltered from the rain because calcium sulfate had not dissolved and washed away in these areas. The epoxy resin applied to strengthen these surfaces did not penetrate the stone and stabilization was not achieved. However, deteriorated marble in exposed, rain-washed positions was successfully consolidated. Domaslawski demonstrated that satisfactory treatment, in general, can be obtained with sandstone of at least 14% porosity and limestone of at least 28% porosity. It is Gauri's opinion that successful impregnation can be obtained with limestone with much less void space. However, a low-porosity stone that degrades by a very shallow surface erosion is not a good candidate for treatment with epoxy resin and may be better protected by an effective water repellent.

| Stone                | % Porosity | Time for Capillary Rise, minutes |     |      |
|----------------------|------------|----------------------------------|-----|------|
|                      |            | Amount of Rise, cm               |     |      |
|                      |            | 2.5                              | 7.5 | 15.0 |
| Sandstone Nietulisko | 22         | 1                                | 8   | 43   |
| Sandstone Zerkowice  | 14         | 4                                | 22  | 110  |
| Limestone Welcz      | 28         | 32                               | 187 | –    |
| Limestone Pinczow    | 30         | 26                               | 156 | 598  |

Table 3. Comparison of the rate of capillary rise of an epoxy resin solution between sandstones and limestones of similar porosity (Domaslawski 1969). [Epoxy resin is 10% bisphenol diglycidyl ether (84 parts) and triethylenetetramine (16 parts) in toluene and methanol (1:2).]

The surface activity characteristics of the stone as measured by relative rates of capillary rise are another factor that has to be considered in determining treatability. Domaslawski's differentiation of porosity requirements for different types of stone is based on studies of sandstone and limestone of similar porosity that show sharp differences in their ability

to transport epoxy resin solutions. He found that the capillary rise of 10 and 20% solutions in sandstone of 22% porosity was one to two orders of magnitude faster than in limestones of even higher porosity (Table 3). It appears from this data, and from the success that other workers have had consolidating different types of substrates with epoxy resins, that the order of decreasing treatability is: synthetic cast sandstone, natural sandstone, and then limestone. Unfortunately, limestone has the greatest need for consolidants that can provide mechanical strength.

### **Polymer Migration**

When a resin solution is placed in contact with stone, there is a tendency for smaller solvent molecules to flow into a porous substrate more easily and more deeply than larger oligomeric resin molecules. This inevitably leaves higher resin concentrations near the surface. The degree of separation between solvent and solute is determined by a number of characteristics beyond molecular size, such as differences in polarity of the solvent and solute and the pore/capillary structure of the stone. There is, however, another factor leading to higher resin concentration near the surface—reverse migration. This is the tendency of the solution moving toward an uncovered surface to lose solvent by evaporation from the stone and to deposit resin on the surface. Thus, the highly concentrated polymer in outer areas may not only be due to a chromatographic effect but can also be increased by reverse migration. Kotlik (1983) demonstrated that when cubes of sandstone were impregnated with an epoxy resin in toluene and acetone, samples that were wrapped in polyethylene and aluminum foil for two weeks showed a greater depth of penetration than those that were not wrapped. Factors that influence the movement of solution through the substrate will affect the pattern of polymer deposition. Whether this is a return of polymer to the surface as solvent evaporates, or movement in some other direction, depends on the treatment.

Polymer migration has also been demonstrated by Cuttano et al. (1981). They achieved complete impregnation of Matera tuff cubes by immersing them in epoxy resin solution. They also obtained excellent capillary rise by placing 3 x 5 cm blocks of this material vertically into a resin solution 1 cm in depth. In contrast to various silane-derived consolidants, which were found distributed evenly through the stone, the epoxy resin was found in relatively greater quantity near the exteriors in the segment of the block above the solution, due to migration of the resin towards the surface during evaporation of the solvent.

The problem with reverse migration is not only that it causes a concentration of resin near the surface where it can darken, but it also moves resin from deep within the stone, where it is most useful, to the surface. What is needed is movement of the polymer in the opposite direction, i.e., forward (inward) migration. There are a number of ways in which forward migration of resin molecules can be achieved. The obvious approach is to prevent the solvent from evaporating from the surface. In the laboratory, this can be accomplished by total immer-



sion of the sample in consolidating solution or by maintaining the sample in a solvent-saturated atmosphere until the resin has cured. In practice, the treated object can be tightly wrapped with film until polymerization and bonding of the resin to the stone renders the consolidant immobile. Forward migration by blocking solvent evaporation can also be accomplished when treating larger objects by maintaining a flow of consolidating solution over the surface of the piece for a sufficient period of time (Domaslowski 1969, Kotlik 1983).

Kotlik (1983) has found another approach to obtaining inward migration. He uses relatively high resin concentrations, in the range of 50%, forcing resin deeper into the stone. Obtaining deeper penetration by using more concentrated solutions runs contrary to general expectations. However, a number of experiments demonstrate that this increases both the amount of resin absorbed by the stone and the depth to which the resin migrates. Most impressive are the experimental results shown in Figure 3, which illustrates the pattern and extent of impregnation achieved in blocks of fine-grained sandstone treated with resin solutions at concentrations ranging from 5.6 to 75 weight percent. The depth and extent of penetration increased gradually until the concentration reached 50%. At this level, the stone was completely saturated with resin. Impregnation dropped when a 75% solution was used.

In this study, sandstone blocks were immersed in solutions of bisphenol A diglycidyl ether (MW = 460) and diethylenetriamine in a methanol-toluene co-solvent for three hours, and then were wrapped in aluminum and polyethylene sheets for two weeks. These steps

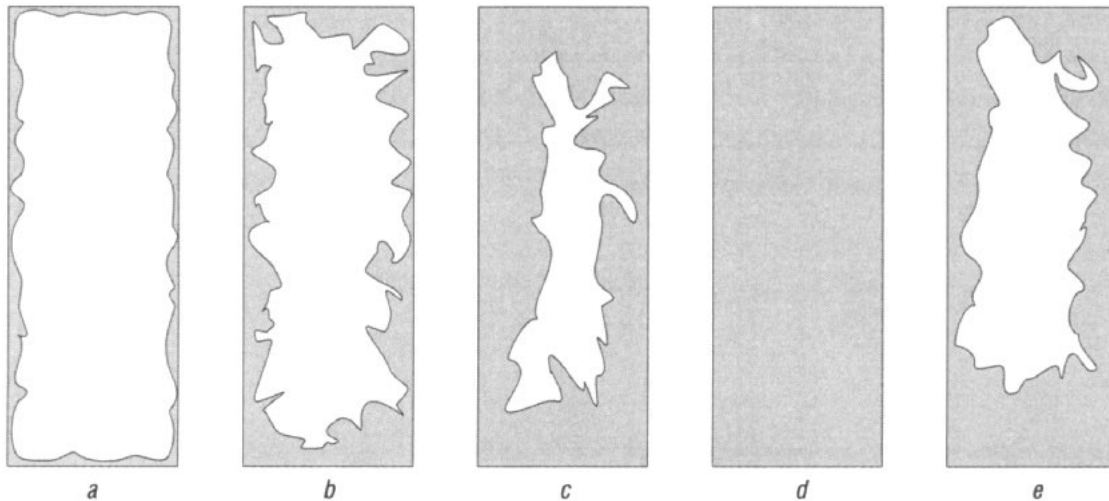

Figure 3. Cross sections of sandstone samples after impregnation by immersion in epoxy resin solution, MW= 460, hardener DETA. Concentration of solution: (a) 5-6%, (b) 10%, (c) 30%, (d) 50%, and (e) 75%. All concentrations are by weight. Impregnated area is indicated by dots (Kotlik 1983).

eliminated reverse migration. In the immersion phase, the lower molecular weight, more mobile solvent molecules penetrate the pore structure more easily than the resin. However, as the resin concentration increases, the concentration differential increases and forces the resin to flow more deeply into the stone.

Forward migration of the resin provides additional penetration after the object is removed from the solution and wrapped. The solvent cannot leave through the blocked surface but instead, with time, flows into interior void spaces. The resin cannot leave the stone in any event. When immersion is terminated, the resin is concentrated near the exterior faces. After wrapping, as solvent moves to the interior, the concentration gradients force the resin to deeper penetration. Given enough time, a reversible consolidant would equilibrate evenly through a stone of any dimension. With the cross-linking of growing resin chains and the precipitation of polymers that have strong surface bonding characteristics, such extreme penetration is not likely, but solvent ratios and other factors can be adjusted to improve forward migration.

The concentration effect was also demonstrated in capillary rise experiments. Figure 4 shows cross sections of sandstone samples that were treated much like the Cuttano samples (see p. 24). Note that the 10 weight percent sample gave resin concentrated near the surface in the stone volume above the epoxy resin solution in the same manner as the tuff pieces treated by Cuttano. However, when the concentration was increased to 30%, the entire cross section was impregnated. But, while more concentrated solutions give better impregnation, larger, more viscous resins do not. Figure 5c shows the poorer penetration provided by a bisphenol A diglycidyl ether with a higher molecular weight.

Kotlik found that using higher resin concentrations to provide deeper penetration provided a better quality of consolidation. Table 4 shows these benefits as the concentration of resin is increased from 2.9 to 30%. The samples were immersed at reduced pressure for three hours. At a 2.5% polymer loading, obtained by using a 30% solution, the sandstone showed

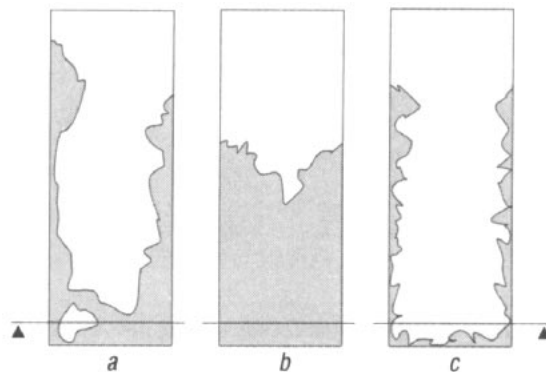

Figure 4. Cross sections of sandstone samples after impregnation by capillary rise with bisphenol diglycidyl ether resin solution: (a) epoxide MW= 460, concentration 10%; (b) epoxide MW= 460, concentration 30%; (c) epoxide MW= 1710, concentration 10%; hardener DETA. All concentrations are by weight (Kotlik 1983).

| Concentration of Resin % | Weight Increase % | Weight Increase % After 48 Hours of Water Immersion | Weight Change % After 30 Na <sub>2</sub> SO <sub>4</sub> Crystallization Cycles |
|--------------------------|-------------------|---|---|
| 2.9                      | 0.34              | 8.5   | -20   |
| 5.6                      | 0.66              | 7.3   | -9  |
| 15.0                     | 1.14              | 4.9   | 2   |
| 30.0                     | 2.54              | 0.6   | 0   |

Table 4. Samples of Horice sandstone were immersed in solutions of bisphenol A diglycidyl ether (MW= 460) and diethylenetriamine in a methanol-toluene co-solvent (Kotlik 1983).

almost no tendency to absorb water and no change in weight after 30 sodium sulfate recrystallization cycles.

The improved penetration that is obtained with longer durations of contact between solution and stone is illustrated in experiments comparing brushing and flow procedures. Repeated brushings on one face of a 5 x 15 x 30 cm sandstone slab were done for as long as solution was taken up into the stone. In the continuous flow experiments a cellulose wick was soaked in solution and bound to one face of the slab. The flow was maintained against the stone surface by recirculating the solution that was collected in a lower vessel and returned to an upper vessel. No wrapping was used for solvent retention. In the first flow experiment, contact could be maintained for only 5.5 hours because the combination of high resin concentration and a toluene-ethanol co-solvent caused accelerated curing and a rapid increase in viscosity. In the second flow experiment, the toluene was replaced with acetone. This slowed polymerization and permitted the application of resin to be continued for 10 hours. The slabs were cut open and the depth of penetration was determined by neutron radiography. The results are shown in Figure 5. The first two illustrations show the patterns of impregnation obtained by brushing. Figure 5a shows the result of brushing the top of a horizontal surface, while 5b demonstrates the penetration obtained on a vertical slab. Brushing a vertical surface results in a relatively even penetration of about 5 mm with most of the resin accumulating in a dense region close to the surface. The flow treatments gave penetrations of 1 to 3 cm without a dark, concentrated layer near the surface. The 10-hour period of treatment appears to have provided the deepest, most uniform distribution of epoxy resin (Fig. 5d).

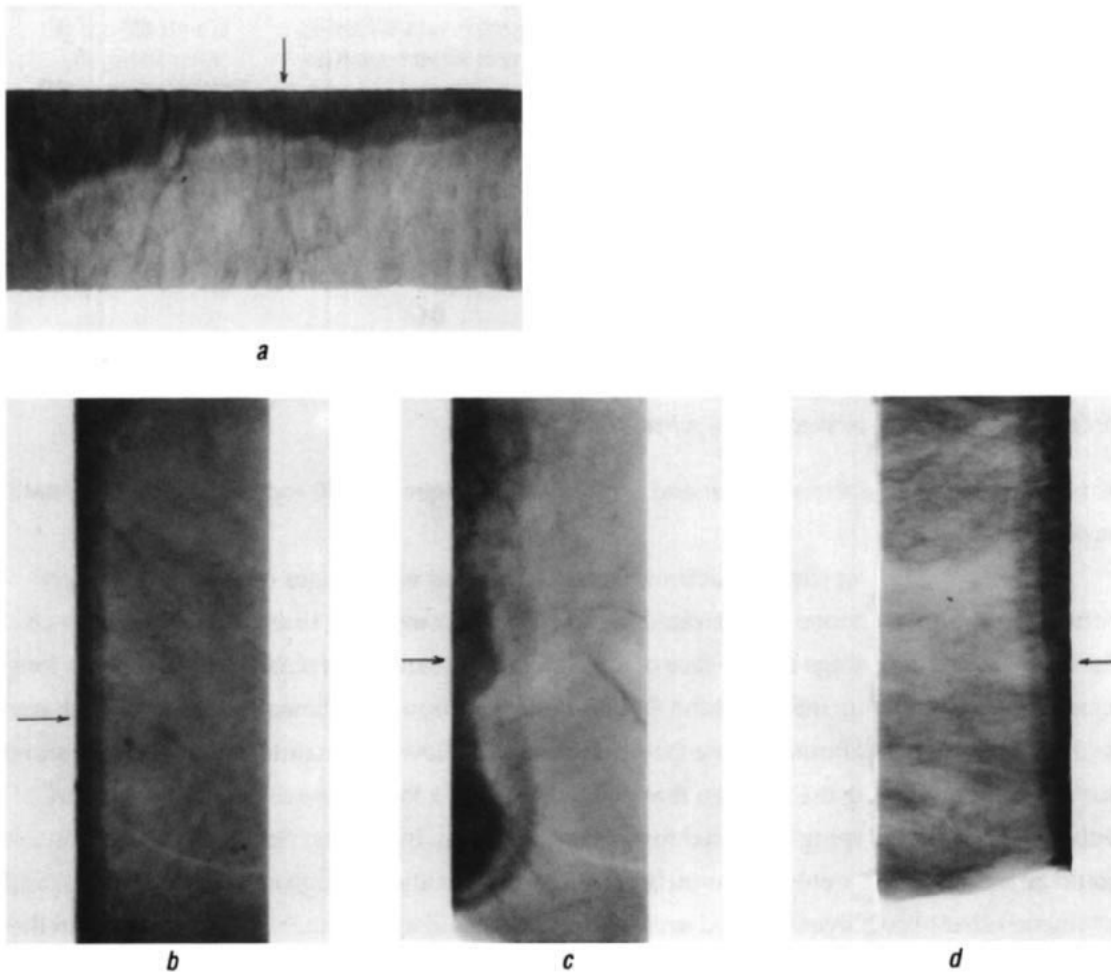

Figure 5. Penetration of epoxy resin into sandstone slabs. (a) Brushing on horizontal surface. (b) Brushing on vertical surface. (c) Contact flow for 5.5 hours. (d) Contact flow for 10 hours (Kotlik 1990).

## Color Formation

The presence of multiple amine groups and phenoxymethylene functionality in cured bisphenol A-derived resins provides ample opportunity for chromophoric structures to form upon exposure to oxygen and sunlight (Alien et al. 1982), and discoloration has been the primary reason for not using epoxy resins for stone consolidation. A number of studies on the light stability of epoxy resins were done to investigate their viability as glass adhesives (Davison 1978; Tennent 1979; Down 1983, 1985). Down points out that while acrylics, polyester, nitrocellulose, cyanoacrylate, poly(vinyl acetate), and poly(vinyl butyrate) were tried as glass conservation adhesives, they failed due to inadequate bonding strengths, slow curing, excessive shrinkage, or chemical instability. Epoxy adhesives generally do not exhibit these deficiencies, and solving the

discoloration problem should yield an ideal bonding agent for glass.

Tennent attempted to find the most suitable formulation by evaluating the color stability of six commercial epoxy resins after extended outdoor daylight exposures, and after exposure to MB/U and MBTL lamps for periods of up to 1000 hours. Down screened 55 similar products under a wider range of conditions so that colorfastness could be estimated for a variety of light intensities for periods of up to 100 years. The first part of Down's study measured the yellowing that occurred in the dark after curing. She measured the absorbance of films at 380 nm every six months over a four-year period. Removing blue-purple light at this wavelength creates yellowing. In the second part of the study, Down looked at similar films that had been aged for up to 1000 hours in an Atlas Weather-Ometer equipped with a 6500-watt Xenon arc lamp and infrared absorbing filters. Correlations were made between the amount of radiation provided experimentally, the degree of yellowing and the estimated illumination rates for various types of museum locations. For each resin, life expectancies, in terms of the time required to reach two critical levels of yellowing, were determined after storage in the dark, after exposure to fluorescent lamps, and after placement near northern and southern (full sunlight) windows. The first level represented a point below which yellowing was not seen, and the second was an absorbance level above which yellowing was unacceptable.

The research by Down showed that the composition of the amine hardener is the most critical factor in determining the stability of the cured resin. Her data are summarized in Table 5, which lists estimates of the time required for the resin to go beyond an acceptable level of yellowing as a measure of the relative stability of films kept in the dark or placed in direct sunlight. A wide variety of amine types was available in different commercial products where the epoxy component was bisphenol A diglycidyl ether. Clearly the unmodified aminopoly(ethyleneamine)s provide the poorest light stability. Any inclusion of oxygen-containing species with aminopoly(ethyleneamine)s in the hardening agent eases the reactivity of this polyamine and lessens color formation. This can be accomplished by premixing some of the epoxy resin with the aminopoly(ethyleneamine) or by using the reaction product of the polyamine with a higher fatty acid. The best results appear to occur when poly(ethylene oxide) is an addend, particularly where an amidopolyamine is used with the aliphatic polyether. There is no explanation given why Epo-Tek 301-2 and Ablebond 342-1, which consist of the same component types, a bisphenol A diglycidyl ether and a blend of poly(ethylene oxide) and aminopoly(ethyleneamine), demonstrate such different light stability properties. These improvements are in step with the necessity of substituting less volatile and less toxic amines for the aminopoly(ethyleneamine)s.

| Amine Hardener   | Product             | Stability in Dark Years | Stability in Sunlight Years |
|--|---------------------|-------------------------|-----------------------------|
| Triethylenetetramine   | Araldite 6010/HY951 | 2                       | <1                          |
| Mixed aminopoly(ethyleneamine)s (APEAs)                        | Araldite 6010/HY956 | 3                       | <1                          |
| Poly(propylene oxide)diamine                                   | Quick-i-poxy        | 12                      | 1                           |
| Aliphatic acid amides of APEAs                                 | Hysol 0151          | 19                      | 11                          |
| 2,2,4-Trimethylhexamethylene-diamine and alkyl glycidyl ether  | Epo-Tek 301         | 38                      | 7                           |
| APEAs and epoxy resin  | Epoxyglass          | 42                      | 6                           |
| Poly(ethylene oxide) and APEAs                                 | Epo-Tek 301 -2      | 51                      | 24                          |
| Poly(ethylene oxide) and APEAs                                 | Ablebond 342-1      | >100                    | <1                          |
| Aliphatic acid amides of APEAs and poly(ethylene oxide)diamine | EC2216              | 20                      | 38                          |

Table 5. Effect of amine hardener type on the stability of bisphenol A diglycidyl ether resins (Down 1984, 1986).

It is often suggested that the best approach to obtaining epoxy formulations with better color stability involves replacing aromatic bisphenol A glycidyl ethers with aliphatic epoxy resins (Cavaletti et al. 1985). The cycloaliphatic resin obtained by hydrogenating bisphenol A, Eponex 1510, has found widespread use because of its colorfastness in applications such as wood consolidants, particularly when mixed with diaminopoly(propylene oxide). The cycloaliphatic resin EP 2101 is advocated by Cavaletti because of its remarkably low yellowing index. However, when it was used to consolidate portions of an ancient Roman aqueduct of Viterbo Tuff, a striking change in color appeared soon after consolidation. After two years the color was less noticeable. In the Down studies, only one aliphatic resin, Epo-Tek 305, based on 1,2,3-tris(2,3-epoxypropoxy)propane, was evaluated. Its use with unmodified triethylenetetramine provided no significant improvement in color stability over bisphenol A diglycidyl ether. It seems that better resistance to discoloration can result by using aliphatic epoxies in place of aromatic resins but that replacement by itself does not guarantee the absence of color problems.

Several preservationists have found that the composition of the resin has been immaterial in dealing with color problems. They have found that using procedures that carry the resin deeply and evenly into the stone and leave a minimum concentration at the surface give satisfactory results. Domasowski and Strzelczyk (1986), commenting on the results of their consolidation of three historic portals in Poland, stated that objects treated with 10-15% solutions in a correct manner do not show any change in color after several years. In their opinion, poor color

results have been due to the incorrect application of resin. Gauri has recommended removing resin remaining on the surface by wiping with solvent or using a light abrasion. In the treatment of the California Building in San Diego, the epoxy resin was applied as an acetone solution and the residual polymer was washed from the surface with acetone. This building exhibited no discoloration after consolidation (Szabo and Szabo 1982). The application approach to colorfastness requires first that the consolidating solution be held in place by a tight wrapping to enable the resin to cure and bond at some distance into the stone and not to return to the surface as solvent evaporates, and that the surface must be wiped with a solvent or be abraded lightly to remove any polymer remaining on the surface. The stone conservator should be able to demonstrate that specific color problems can be eliminated by immersing a small slab of representative stone in the epoxy solution, wrapping it tightly with plastic film after retrieval, allowing the resin sufficient time to cure, removing the wrapping, and scrubbing one surface with solvent. If the cleaned surface shows discoloration, then the chosen consolidation probably will not work and should not be attempted.

The light-catalyzed oxidative deterioration of resin that causes color formation and chalking gradually removes polymer from the outer surface of the stone. This degradation is restricted to a very thin, outer layer (Schweinsberg and George 1986). Where the resin sits as a relatively thick crustal coating, the discoloration will gradually worsen. However, when most of the polymer has been carried off or wiped away, whatever remains will be oxidatively removed and the surface of the stone should return to its original appearance. A good example of this can be seen in the consolidation done on the Crescent Hill Baptist Church in Louisville, Kentucky (Fig. 6). This building was clad in synthetic stone that had weathered to the point that pieces of stone were falling on people; obviously, strengthening was needed. This was achieved in 1983 with the use of procedures developed by Gauri, using commercial bisphenol A diglycidyl ether-aminopoly(ethyleneamine) resin in acetone solution. Soon after the work was done the treated surfaces had yellowed. When the church was reexamined in September 1989 the color was gone from all exposed surfaces, but yellow discoloration could still be seen in areas where bushes prevented access to sunlight. This "removal from the surface" approach to color stability allows the preservationist to concentrate on issues of resin cost, mechanical strength, penetration, and curing rate.



*Figure 6. Exterior of Crescent Hill Baptist Church, Louisville, Kentucky, treated with epoxy resin in 1983. Figure shows the tones of the treated surface in 1989.*

## **Resistance to Biodegradation**

Up until recently, biodegradation was not considered to be a significant mechanism in the deterioration of stone or stone consolidants. It is now recognized that biological attack on these systems can cause decay and may act in concert with traditional chemical and physical mechanisms of degradation (Koestler et al. 1985, 1987 a, b, c). Studies by Koestler et al. have shown the role of microbiological agents in the breakdown and recrystallization of stone and protectants. Fungi have been found to be among the most destructive microbiological agents, particularly in tropical climates (Webley 1963, Henderson and Duff 1963, Hueck van der Plas 1968). Koestler's research examined acrylic polymers, poly(vinyl acetate)s, silane derivatives, a polyurea, dammar, and shellac. All resins exhibited fungal deterioration although there was wide variation in the degree of attack which seemed to show little relationship to polymer type. Pankhurst et al. (1972) also studied epoxy resins and found them to be resistant to microbial decomposition. Riederer (1981) mentioned that six years after impregnating bricks on the Rankot-Vihard at Polonnaruw, Sri Lanka in 1970 with a solution of an epoxy resin there was no sign of the vegetation that had been seen in untreated areas. Domasłowski and Strzelczyk (1986) examined the



ability of a bisphenol A diglycidyl ether-triethylenetetramine resin to resist fungal and algal attack six months after being put into limestone and sandstone blocks by conventional impregnation procedures. Treatment was done with alcoholic solutions of resin with concentrations of 5,10,15 and 20%. Surfaces were inoculated with organisms washed from rocks overgrown naturally with algae and fungi. Samples were kept at 100% relative humidity under a Flora ultraviolet lamp at room temperature. After seven weeks, there was extensive fungal growth on limestone and sandstone samples, both treated and untreated, but no sign of algae was noted. Of the nine forms of fungi, *Aspergillus fumigatus* predominated, followed by the *Stemphylium* and *Cladosporium* species. The largest amount of growth occurred on blocks treated with epoxy resin solutions of the lowest concentration, i.e., 5 and 10%. In samples where a 20% concentration of resin was used, the growth of fungi was less than on unimpregnated stone. The epoxy resin may function to deter microbiological growth through a polymer degradation mechanism that cleaves ether linkages to leave free, biocidal phenolic groups. It is also possible that the polyamine functionality, either from unreacted hardener or as part of a cured system, is the source of the nutrient providing for whatever fungal growth occurs. More work needs to be done to identify components that provide nutrients, but bisphenol A diglycidyl ether formulations appear to be promising stone consolidants that resist biodeterioration.

#### Note

1. Ullrich describes a novel procedure for determining the compressive strength of consolidated stone as a function of distance from the surface from measurement of the apparent specific gravity and the Shore scleroscope hardness:  $\text{Logarithm Compressive Strength} = \text{Constant}_1 + \text{Constant}_2 \times \text{Specific Gravity} \times \text{Hardness}$ .



# 5 Nonsolvent Systems

## Low-Viscosity Formulations

Attempts to avoid problems associated with the use of solvents have focused on blending epoxy resin formulations with low-viscosity components, or raising application temperatures of resin systems of moderate viscosity.

In the early 1970s, Munnikendam (1971, 1973), in an effort to find a solventless epoxy system for stone repair, experimented with a number of resin components to find a formulation with the lowest possible viscosity. Epoxy resins that are used as adhesives have a high viscosity, which is generally an advantage for that application. Common commercial bisphenol A diglycidyl ethers have viscosities of 10,000-16,000 cP at 25 °C (Table 6). However, many commercial applications require lower viscosities, and bisphenol A diglycidyl ethers are often diluted with 10-12% butyl glycidyl ether. This epoxy compound has a viscosity of only 3 cP, and the use of modest amounts with bisphenol resins can lower viscosities to 500-700 cP. This is still much too high for treating stone—for good penetration, a solution should have a viscosity close to that of water, i.e., 1.0 cP or lower.<sup>1</sup>

To get around this limitation, Munnikendam considered three very low molecular weight diepoxides as his basic resin component and chose butanediol diglycidyl ether over butadiene diepoxide and vinylcyclohexene dioxide for reasons of toxicity and reactivity. It was necessary to use a very hindered amine [1-methyl-1-amino-4-(dimethylaminomethyl)cyclohexane (menthane diamine)], to balance the high reactivity of the small diepoxide. Both components have a viscosity of 10 cP. A 5:2 mixture of epoxide to amine has the same viscosity and has a reasonable pot life and good color, but this viscosity is still considered too high for good penetration. Diluting the formulation with an equal amount of tetraethyl silicate (0.6 cP) lowers the viscosity to an acceptable 2.0 cP. While some aspects of the behavior of tetraethyl silicate are similar to solvents, this silane ester also functions as a consolidant. Munnikendam suggested that the tetraethyl silicate also reacts with the curing resin but gave no evidence for this reaction. In a brief comparative evaluation of consolidants used conventionally for stone treatment, 4-cm cubes of tuff and sandstone were treated with this formulation and also with several acrylic resins, alkoxysilanes, and epoxy resins in solution. All were subjected to four-hour sodium sulfate crystallization, humidity, and temperature cycling for several weeks. The samples treated with the Munnikendam system showed the least deterioration.

Comparable formulations in the hands of others did not fare as well. Rossi-Manaresi (1975) studied a variety of consolidants on a sandstone used widely in Bologna. The stone had high porosity and contained 30-46% calcite that functioned as a binder. The Munnikendam formulation, as well as silanes, silicones, acrylics, and mixtures of the latter materials, were tested both on freshly quarried cubes and on small areas of buildings. Munnikendam applied his mixture by wrapping saturated cotton wadding against the stone with polyethylene

film. However, the formulation did not penetrate well and left a discoloring crust on the surface. Other work with porous marine limestone also yielded poor results and did not provide satisfactory penetration (Rossi-Manaresi and Ghezzi 1978).

| Epoxy Compound   | Viscosity (cP) at 25 °C |
|--|-------------------------|
| Diglycidyl ether of bisphenol A containing oligomer; standard commercial liquid resin. Eq. wt. = 180-200 | 10,000-16,000           |
| Diglycidyl ether of bisphenol A without oligomers. Eq. wt. = 170   | 3600                    |
| Hydrogenated diglycidyl ether of bisphenol A containing oligomers  | 1500                    |
| Triglycidyl ether of trimethylolpropane  | 400                     |
| 1,4-butanediol diglycidyl ether  | 19                      |
| Vinylcyclohexene diepoxide   | 10-15                   |
| Butyl glycidyl ether   | 3                       |

Table 6. Viscosity of epoxy compounds.

The use of epoxy resin-alkoxysilane mixtures has been advocated in more recent studies where quantitative comparisons were made on a large number of polymer-silane combinations used to consolidate 31 Gandharan sculptures (Proudfoot et al. 1988). These sculptures, originally from the Peshawar Valley in Pakistan, had been on display outdoors in southwest England for nearly 100 years and were in various states of deterioration. They were made of mica schist, phyllite, or serpentinite and all were of low porosity ranging from about 2 to 5%. Areas with severe deterioration had much higher porosity, and this was not due to pollution, but the result of harsh winds and a rainy environment with wide temperature swings. Soluble salts also contributed to deterioration. Consolidation experiments were made with silanes (methyl trimethoxysilane, tetraethyl silicate,  $\gamma$ -methacryloxypropyltrimethoxysilane and  $\gamma$ -glycidyl oxypropyltrimethoxy silane), an acrylic resin (Paraloid B-72), and an epoxy resin (bisphenol A diglycidyl ether and triethylenetetramine). In some cases, the silanes functioned as reactive solvents for the epoxy resin or the B-72. The studies examined the effectiveness of these systems for consolidating limestone powder, binding the laminations of the mica schists, penetrating the low-porosity stone, providing resistance to one molar hydrochloric acid, avoiding discoloration, and diminishing the porosity of the Gandharan stones. The limestone powder treated with epoxy resin withstood the acid attack very well, while the acrylic polymer provided less protection and the silanes were least effective. Tetraethyl silicate was least effective and left a product that was relatively soft and powdery,

though stronger than untreated material. The authors noted that the methyltrimethoxysilane took the epoxy resin farther into the stone than acetone but gave a weaker product. It therefore improved the penetration of the epoxy and reduced the darkening effect. They concluded that the combination of an epoxy resin with a compatible silane may be an option for consolidating the foliation of Gandharan stone. It strengthened the laminations, penetrated just as well if not better than the B-72/methyltrimethoxysilane solutions, and it provided more strength. The epoxy-silane system darkened the stone, but according to Proudfoot it could be cleaned. Poul-ticing to remove soluble salts was still possible. The authors have advanced from the ethyl silicate-butane diglycidyl ether combination of Munnikendam to a bisphenol A-based resin and methyltrimethoxysilane to get these advantages, and they provide evidence that results are due to the penetrating and carrying power of the silanes and not to the reaction with the epoxy compound. Despite the advantages found for the silane-epoxy resin combinations, the authors recommend it only for cases where delamination is severe and indicate that they would use more "tested" consolidants, such as ethyl silicate, for overall consolidation. Nevertheless, a promising area of research is the examination of other formulations, such as methyltriethoxysilane, hydrogenated bisphenol A diglycidyl ethers, and amine ethers.

## Application of Epoxy Resins at Elevated Temperatures

Raising the temperature of an epoxy resin lowers its viscosity and enables some solventless systems to achieve good penetration in stone; it also increases the curing rate of the resin. Moncrieff and Hempel (1970, 1977) considered these factors when they consolidated statues of highly weathered marble. Their initial studies showed that porous, deteriorated 100-year-old marble was effectively impregnated after immersion in a solventless epoxy resin-amine formulation heated to 72 °C. The epoxy compound was a conventional bisphenol A diglycidyl ether, but the viscosity of the commercial resin, Marasett A655, was reduced by adding dibutyl phthalate. Similarly, the curing agent was a blend of benzyldimethylamine, triphenylphosphite, and dibutyl phosphate. The viscosity of the combined resin and hardener was 700 cP at room temperature. Resin take-up, using either atmospheric or vacuum procedures, was slightly over 1% of the weight of the stone. Based on these results, consolidation of a small statue in poor condition was undertaken. It was necessary to surround the *River God*, which was situated on the grounds of the Victoria and Albert Museum, with a substantial amount of insulation in order to bring it to 72 °C with electric heaters and hold it at that temperature for a week. Resin was applied by brush in two sessions, but working in the hot, close environment was difficult and unpleasant, and it was not possible to apply the polymer evenly. Initially the statue took on an unsatisfactory white bloom when it became wet, but after two years this ceased. There was no further stone deterioration.

It was concluded that the relatively high temperature of treatment caused the resin to oxidize during application and this could be minimized by wrapping a protective sheet around the object to exclude oxygen. The next study involved the treatment of an old, deteriorated tombstone which was done in a manner to facilitate application and the subsequent wrapping in a plastic sheet. Polyethylene terephthalate was chosen as the wrap because it has very low oxygen permeability. The stone was placed securely on the roof of the museum and then surrounded by an insulating tent of metallized polyethylene terephthalate and tarpaulins. It was heated to 70 °C, brushed twice with Marasett A655, quickly wrapped in the polyester film, and kept at 70 °C for an additional 20 hours. The treated stone was then arranged to have maximum exposure to rainwater running off the roof and to all of the elements of the London environment. After six years of exposure, it showed no discoloration or physical breakdown, and an examination of a cross section found that the resin impregnated all of the porous, weathered outer structure and connected it firmly to sound stone.

Based on these results, Moncrieff and Hempel (1977) undertook the consolidation of the *Virgin and Child*, a statue by Pyrgotelis on the facade of the Church of Santa Maria dei Miracoli in Venice. The Carrara-like marble was in an advanced state of decay. It was treated following the steps described above using a resin consisting of seven parts of hardener, Marasett H555, to 100 parts of Marasett X555. After application of the resin, polyethylene terephthalate film was pressed tightly against the treated surface to prevent atmospheric oxygen from reacting with the polymer and affecting the cure. Some whitening of the surface occurred after heavy rains for a while, but this gradually disappeared. An inspection four years after treatment found that deterioration had been arrested and there was no further discoloration.

### Note

1. Intermediate viscosity mixtures are sold commercially and are used for the consolidation of fragile wood (Phillips and Selwyn 1978). The use of higher concentrations of the monoether to lower viscosities further is not practical because the monofunctional epoxide is a polymer chain terminator.

# 6 Comparison of Epoxy Resins with Other Consolidants

From the time of their commercial availability, there has been interest in comparing the properties of epoxy resins with other consolidants. Unfortunately, the methods of preparation of test substrates, i.e., the procedures for stone impregnation, were often those of general convenience or those recommended by manufacturers who had other end uses in mind. Inevitably, the resin was not distributed in an optimal manner and, while there was impressive improvement in mechanical strength, resin concentrated near the surface became discolored and threatened to break off in crustal layers.

One of the more comprehensive comparative studies of consolidants was carried out by Rossi-Manaresi (1975, 1981) to find a way to stabilize fourteenth-century historic buildings in Bologna. These monuments, constructed of locally quarried yellow sandstone, were in an advanced state of deterioration with the surface skin peeling off and the layer underneath turning to sand. Dissolution of the calcitic cement in the sandstone was the principal decay mechanism. In some areas, particularly where extensive leaching by rainwater had occurred, the surfaces were intact and there was no spalling or exfoliation of stone, but at depths of up to 1 cm, the stone was much more porous than the core beneath. To a lesser extent, in other areas, it was clear that salt recrystallization had caused exfoliation. The research and test application of chemicals to correct these problems were done in 1973, and the impregnations were reevaluated eight years later. For deteriorating stone under compressive stress, there are few simple options for restoring the required mechanical strength. Insertion of a structural metal rod is not practical, and most resins provide little mechanical strengthening. The exception to this is found in epoxy resins. Such resins, based on aromatic structures, e.g., bisphenol A diglycidyl ethers, were avoided in this study because they were thought to be too viscous, too prone to discoloration, not sufficiently resistant to chemical attack, and too hydrophobic for the impregnation of even slightly damp stone. It was proposed that aliphatic epoxy resins would not have these disadvantages and the study focused on butanediol diglycidyl ether, i.e., the Munnikendam formulation and on pentaerythritol tetraglycidyl ether. These were compared with several formulations based on silane esters: oligomerized methyltrimethoxysilane in aqueous cellosolve, 15% methylphenyl polysiloxane in trichloroethane, an aqueous dispersion of a silicate-acrylic copolymer, and two formulations based on mixtures of methyltriethoxysilane and ethyl silicate.

Sandstone blocks from several monuments and from a quarry were cut into 4-cm cubes to provide the substrates on which to evaluate the consolidants. The evaluation considered porosity changes and increases in mechanical strength. Ultrasonic tests were used to measure the strengthening of friable material. To determine improvement in the resistance to deterioration caused by aqueous corrosion, measurements of water absorption by capillarity

and saturation coefficient, as well as accelerated aging tests by cycles of wetting and drying in the presence of sulfur dioxide, were carried out. Penetration was determined on a cross section of a cube by watching the behavior of water droplets placed in a line perpendicular to an outer edge. In general, the study found that procedures that carried the consolidant deeply into the stone, whatever the consolidant was, provided good stabilization, and poor penetration did not. Thus, spraying with a polysiloxane was generally ineffective. However, a slow, prolonged percolation with a different but similar polysiloxane resulted in a penetration of 7 cm and preserved all of the surface scales and flakes intact.

In the 1975 report describing the initial work, the author declared the B-72 polysiloxane mixture in trichloroethane to be the best consolidant. This is the so-called "Bologna Cocktail," and it increased the strength of weathered rock from 249 to 419 kg/cm<sup>2</sup>, a 68% improvement. Stone treated with this system showed low water absorption and no formation of calcium sulfate after a series of exposures to 4 ppm of sulfur dioxide in air. All of the consolidants in this study, except the two epoxy systems—the butanediol diglycidyl ether-menthane diamine-ethyl silicate mixture and the combination of pentaerythritol tetraglycidyl ether and cycloaliphatic amine without solvent—penetrated the sandstone cubes thoroughly. The Munnikendam system went in to a depth of only about 0.8 cm, and the solventless epoxy resin system provided less than 0.4 cm of penetration. Both resins concentrated near the surface. While the blocks treated with these consolidants showed substantial increases in compressive strength and a sharp reduction in attack by water and sulfur dioxide, it was concluded from the discoloration, poor penetration, and the expectation of future layer detachment that these resins would not be satisfactory consolidants for sandstone. However, after eight years the separation of the crustal layer had not occurred, and the stabilization was judged to be excellent and, in fact, far better than that provided by any of the other consolidants. Appearance was still a problem. The unsightly darkening of the pentaerythritol-based resin was still evident, while the stone treated with the Munnikendam system displayed areas of white discoloration.

This study provided a clear example of the importance of putting epoxy resins into solution when they are to be used for stone preservation. The use of an undisclosed solvent with the pentaerythritol tetraglycidyl ether-cycloaliphatic amine mixture enabled the resin to penetrate relatively low-porosity fresh stone deeply and evenly. A small amount of resin, enough to lower the porosity a modest 5%, was sufficient to increase the compressive strength from 607 to 943 kg/cm<sup>3</sup> and to provide excellent resistance to attack by sulfur dioxide. Distribution of resin away from the surface kept discoloration to a minimum. Unfortunately, this formulation was not tried on weathered material, which precluded longer term comparison with several of the more established alkoxysilane-based consolidants.

De Witte et al. (1985) examined twelve different stone consolidants, including six silane ester combinations, poly(methyl methacrylate), potassium silicate, a polyurethane,



and two epoxy resins. The epoxies, PC 5001 and Episol Fix, were described only as bisphenol A derivatives. Both were applied to three different Belgian limestones as 95% solutions in methyl ethyl ketone, and the PC 5001 was also used as a 10% solution. Impregnation was accomplished by placing limestone blocks into shallow reservoirs of the solutions and allowing the consolidants to permeate the stone by capillary action for 15 minutes. The samples were then wrapped in aluminum foil, except for the treated surface, and allowed to dry at 20 °C and 55% relative humidity for at least two weeks. In this treatment, the methyl ethyl ketone slowed the curing of the resin so that the epoxy compounds were carried into the limestones and then brought back to the surface as the solvent evaporated to leave polymer concentrated at the surface. As expected, the epoxy resins provided products that were generally harder than the other consolidants, but in all cases gave unacceptable darkening. Ethyl silicate was the product of choice for stabilizing limestone.

Nishiura and coworkers (1984) compared the ability of three types of consolidants to inhibit the freeze-thaw deterioration of a porous tuff widely used in Japan for historic monuments. Cylinders of tuff with 30-34% porosity were completely immersed in a 15% solution of B-72 in toluene, a 20% solution of Araldite CY-230 and Epomait hardener in toluene, and a 35% solution of partially polymerized methyltriethoxysilane in an organic solvent. After an hour, the cylinders were removed and dried by standing in open exposure, first at room temperature for four days and then at 60 °C for seven days. The alkoxy silane treatment made the porous tuff resistant to deterioration by freeze-thaw cycles, while the acrylic and epoxy resins had little effect. However, the comparison is weak because much less B-72 was put into the stone than the other consolidants, and the post-immersion treatment would have resulted in very little acrylic or epoxy resin throughout the bulk of the cylinder. The dried blocks picked up 7.0% by weight of silane derivative, 3.8% acrylic resin, and only 2.6% epoxy resin (Fukuda et al. 1983, 1984). Domaslowski has shown that epoxy resins cure very slowly in toluene solution and the evaporation of solvent carries most of the unreacted components back to the surface where curing occurs.

Gauri and Madiraju (1978) compared the ability of several resins (an aromatic epoxy resin based on bisphenol A diglycidyl ether, an aliphatic epoxy resin of undisclosed structure, silicone resins, and a fluorinated acrylic polymer) to protect marble against attack by sulfur dioxide. In one phase of their study, impregnated marble slabs were placed in reaction chambers and subjected to an air flow, containing from 6 to 11 ppm of sulfur dioxide, at 100% relative humidity. The rate of reaction was determined by periodic measurement of calcium sulfite buildup using X-ray diffraction analysis. The results are shown schematically in Figure 7. Gauri found that an aliphatic epoxy resin and several different silicones actually increased the rate of attack over untreated marble. Presumably, these materials were acting as sponges to hold aqueous sulfurous acid against the marble surface. An epoxy resin based on bisphenol A diglycidyl

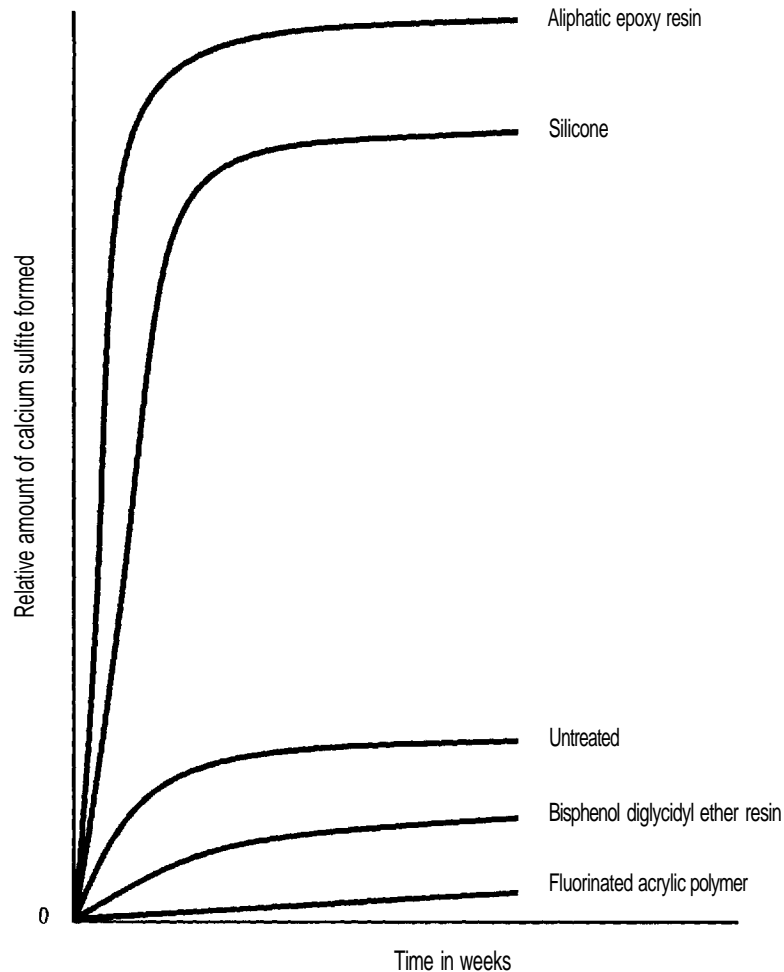

Figure 7. Relative protection of marble against attack by sulfur dioxide and water by different consolidants.

ether provided substantial protection, while fluorinated acrylic resin appeared to suppress corrosion completely. Based on these findings, Gauri advocated a treatment where stone is first impregnated deeply with an epoxy formulation based on bisphenol A diglycidyl ether, and then the surface is treated with an appropriate fluoropolymer.

Clifton (1984) examined 25 commercial materials in an attempt to develop laboratory tests for evaluating the effectiveness of these products as stone consolidants. Little attention was paid to the composition of the various materials. Three epoxy resins were described only as "epoxy." It is likely that these were bisphenol A derivatives employed without the use of solvents. All products were applied according to the manufacturers' directions, generally by brushing. The first screening evaluation offered by Clifton was intended to measure the ability of a consolidant to reestablish bonds between separated stone particles and restore the integrity

of a decayed matrix. Tensile strengths of replicate test bars, prepared by cementing ground sandstone or powdered limestone with the consolidants, were measured. Only 6 of the 25 candidates showed any ability to bind these powders (Table 7). The materials in Table 7 were considered to have passed the first screening. Their ability to penetrate stone was assessed by placing a 3.2-cm column of consolidant on a horizontal surface for one hour and then allowing the absorbed material to migrate for 23 hours. Subsequently, the stone was split open and the depth of penetration was determined visually. The silanes and methyl methacrylate polymer in solution passed completely through the sandstone and were evenly distributed through the block. Epoxy resins showed little or no penetration, which would be expected of a solventless, high-viscosity formulation, and gave products showing much higher discoloration than other materials.

| Sample Number <sup>a</sup> | Consolidant         | Tensile Strength, psi |           |
|----------------------------|---------------------|-----------------------|-----------|
|                            |                     | Sandstone             | Limestone |
| 1                          | Silicone            | 116                   | 148       |
| 8                          | Epoxy               | 1920                  | Failed    |
| 9                          | Epoxy               | 2290                  | 2680      |
| 16                         | Epoxy               | 102                   | 2640      |
| 19                         | Acrylic ester       | 479                   | 1390      |
| 24                         | Methyl methacrylate | 1710                  | 1150      |

a. Other consolidants generally gave test bars with tensile strengths under 100 psi or failed to form a moldable material.

Table 7. The tensile strength of consolidated powdered stone test bars.

To evaluate the protection of limestone against acid rain, test bars were impregnated and subjected to a 40-milliliters-per-minute flow of water saturated with carbon dioxide over a six-week period. The water gradually etched a rut into the stone and the effectiveness of the consolidant was determined by measuring the depth of the rut. Values of 4.0 mm for untreated stone, 1.5 mm for epoxy resin, and 3.2 mm for the next best consolidant, a silane, indicate that the most effective protection against aqueous, acidic erosion is epoxy resin. However, the penetration studies suggest that the epoxy resin ends up as a crustal coating on the limestone slab in contrast to the more uniform distribution by the other consolidants. If this testing procedure is to be useful it has to be shown that polymers are deposited with equivalent concentration profiles.

A still wider range of materials, 51 in all, was evaluated by Sleater (1977) for their suitability as stone consolidants. Like Clifton, Sleater was primarily interested in developing a testing protocol—in this case one that measured the ability of the consolidated stone to resist environmental corrosion and weathering. Stones treated with each reagent were examined and rated after exposure to sulfuric acid and sodium chloride fog, wet-dry and sodium sulfate cycling, and ultraviolet radiation. A special test chamber was designed where the combined effects of thermal cycling and chemical, water, and salt action could be measured. The behavior of each of the consolidants in meeting set criteria was provided. However, each consolidant was described only by a generic name and all were applied according to manufacturers' directions. No consolidant met all the criteria, but none of the commercial silane formulations generally favored for stone consolidation, nor any solvent epoxy system, was included in the study.

A quantitative comparison of consolidants that were applied to sandstone cubes in a manner that avoided concentration of polymer at the surface and allowed forward migration was described in a study by Kotlik (1983). Five-centimeter cubes of Horice sandstone were immersed in solutions of methyltrimethoxysilane, tetraethyl silicate, or epoxy resin under reduced pressure for three hours, and then were wrapped in aluminum and polyethylene film for 14 days. The epoxy resin was a mixture of a bisphenol A diglycidyl ether (MW = 460) and diethylenetriamine that was dissolved in an ethanol-toluene co-solvent. Based on his earlier observations that higher concentrations increased penetration, Kotlik made his comparisons on relatively high concentrations of the methyltrimethoxysilane and epoxy resin. He found that increasing the amount of the silane in an acetone-ethanol co-solvent from 20 to 50% increased the penetration from 3 to 8 mm to complete penetration; a similar result occurred on raising the epoxy resin concentration from 30 to 50% (Table 8).

| Consolidating Solution <sup>a</sup> | Weight of Solution Taken Up % | Weight of Polymer Taken Up % | Penetration |
|-------------------------------------|-------------------------------|------------------------------|-------------|
| 20% Methyltrimethoxysilane          | 9.4                           | 1.0                          | 3-8 mm      |
| 50% Methyltrimethoxysilane          | 11.2                          | 3.0                          | total       |
| 30% Epoxy resin                     | 10.5                          | 3.9                          | 2-20 mm     |
| 50% Epoxy resin                     | 8.3                           | 4.9                          | total       |

a. Silanes were formulated in 1:1 acetone-ethanol. The epoxy resin was dissolved in 1:1 ethanol-toluene.

b. The substrates were 5-cm cubes of Horice sandstone.

Table 8. Effect of consolidant concentration on depth of penetration.<sup>b</sup>

The deep, thorough penetration obtained in this work is in contrast to other studies where lower resin concentrations and little or no solvent generally left the epoxy resin as a surface crust. Commercial formulations of silanes destined for stone treatment are marketed at concentrations of 70% or higher. These studies also showed that the presence of 1% sodium chloride in the stone did not deter penetration.

The effect of type of consolidant on the behavior of the stone with water was studied by separately measuring the capacity of treated stone to absorb water and a light, liquid hydrocarbon (Table 9). This provided some insight on the hydrophobicity and the pore filling characteristics of the consolidants. Methyltrimethoxysilane eliminated 90% of the capacity of the untreated stone to take up water while filling only 10% of the pore volume. Ethyl silicate and epoxy resin showed much less water repellency. In the case of epoxy resin, the reduction in water uptake was close to the amount of polymer deposited in the stone and the reduction in free volume, as determined from benzene (light mineral spirits) measurements.

| Consolidation Solution <sup>a</sup> | Weight of Polymer Taken Up % | Absorption Water <sup>b</sup> % | Absorption of Benzene <sup>c</sup> % |
|-------------------------------------|------------------------------|---------------------------------|--------------------------------------|
| 20% Methyltrimethoxysilane          | 1.0                          | 0.8                             | 8.4                                  |
| 50% Methyltrimethoxysilane          | 3.0                          | 0.9                             | 8.0                                  |
| 20% Tetraethyl silicate             | 1.0                          | 6.2                             | 9.4                                  |
| 30% Epoxy resin                     | 3.9                          | 2.5                             | 5.3                                  |
| 50% Epoxy resin                     | 4.9                          | 2.3                             | 5.7                                  |

a. Silanes are in a 1:1 acetone-ethanol co-solvent. Epoxy resin is dissolved in 1:1 ethanol-toluene.

b. Immersion for 48 hours.

c. Immersion under reduced pressure for 3 hours.

Table 9. Water and benzene absorption into impregnated Horice sandstone.

The improvement in mechanical strength provided by epoxy resins as compared to silicon derivatives was shown by measurements using samples with similar loadings and distributions. Sodium silicate, tetraethyl silicate, and methyltrimethoxysilane each provided about a 50% improvement in compressive strength, while epoxy resins resulted in a 300% or better increase in strength (Table 10). The compressive strength was determined using an instrument produced in East Germany known as a Fiedlungsmessgerete device. Loading the stone with 1% sodium chloride before treatment did not change these results. Because of the lack of homogeneity in this sandstone, the standard deviation of the compressive strength as shown in the table was relatively large. The differences in improvement in mechanical strength would have been much larger if the substrate had been a more fragile, weathered stone.

| Consolidating Solution <sup>a</sup> | Weight of Polymer Taken Up % | Compressive Strength (MPa) | Standard Deviation % |
|-------------------------------------|------------------------------|----------------------------|----------------------|
| None                                | –                            | 15                         | 30                   |
| Aqueous sodium silicate             | 1.0                          | 21                         | 32                   |
| 20% Methyltrimethoxysilane          | 1.0                          | 27                         | 19                   |
| 50% Methyltrimethoxysilane          | 3.0                          | 22                         | 18                   |
| 20% Ethyl silicate                  | 1.0                          | 23                         | 32                   |
| 30% Epoxy resin                     | 3.9                          | 54                         | 26                   |
| 50% Epoxy resin                     | 4.9                          | 44                         | 22                   |

a. Silanes are in a 1:1 acetone-ethanol co-solvent. Epoxy resin is dissolved in 1:1 ethanol-toluene.

Table 10. Compressive strength of treated sandstone blocks (Kotlik 1983).

There is some belief that high polymer loadings will encase salts contained in stone and prevent their removal by washing. The fall-off in benzene uptake that accompanied high loadings of epoxy resin in the sandstone (Table 9) and the water repellency of the silane esters would seem to support the idea that dissolution and removal of the salt after treatment would be inhibited. However, water immersion studies have shown that even at relatively high loadings, of either polymer, desalination occurs (Table 11). The rate of desalination was a function of the concentration of the salt in the stone and did not depend on whether the stone was consolidated (Fig. 8). However, without treatment the salt-laden Horice limestone began to disintegrate when placed in water.

| Sodium Chloride in stone % | Consolidation Solution     | Weight Polymer in Stone % | Amount of Salt Removed | Amount of Salt Removed from Weight of Dried Block % |
|----------------------------|----------------------------|---------------------------|------------------------|---|
| 2.8                        | None                       | –                         | 97                     | 100   |
| 2.3                        | 20% Methyltrimethoxysilane | 1.1                       | 97                     | 100   |
| 1.6                        | None                       | –                         | 100                    | 100   |
| 1.7                        | 30% Epoxy resin            | 3.1                       | 100                    | 100   |

Table 11. Desalination of Horice sandstone (Kotlik 1983).

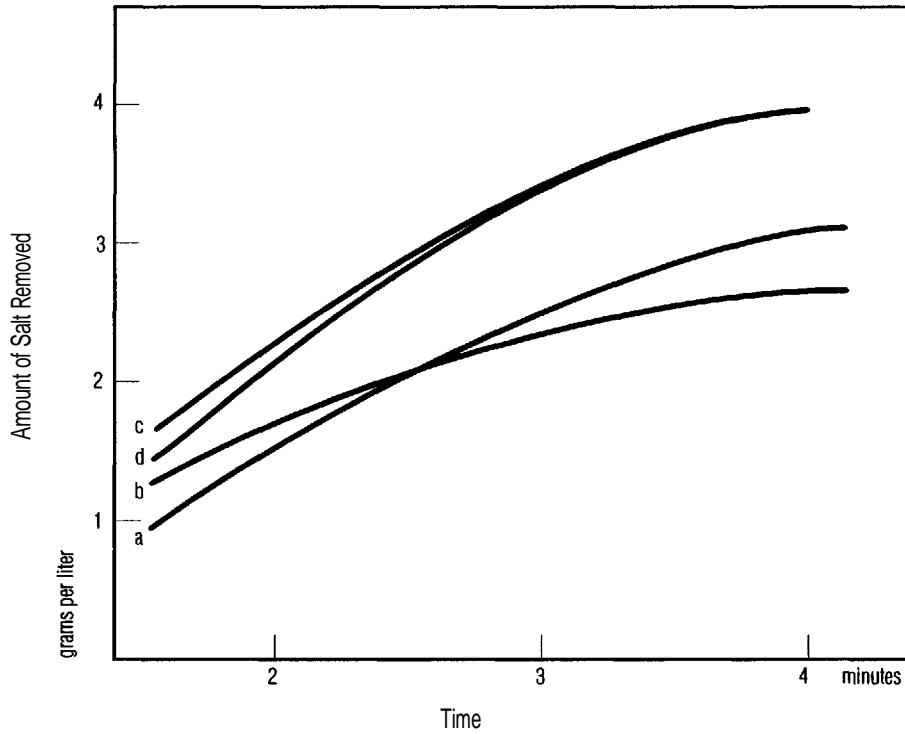

- a. Untreated stone, NaCl at 1.6%.
- b. Stone treated with 3.1% epoxy resin, NaCl at 1.7%.
- c. Untreated stone, NaCl at 2.8%.
- d. Stone treated with silane ester, NaCl at 2.3%.

Figure 8. The removal of salt from Horice sandstone as a function of time and amount of salt in the stone (Kotlik 1983).





# 7 Aliphatic Epoxy Resins

The need to achieve better penetration and easier application of epoxy resins than that offered by solventless systems led to developments in two directions. Industrial polymer research by Marinelli and others has provided new types of aliphatic epoxy resins with low viscosity and good resistance to discoloration. Results of work with these aliphatic resins is the topic of this chapter. In contrast, scientists like Domaslawski, Gauri, and Kotlik have stayed with the readily available and generally cheaper bisphenol A diglycidyl ethers and, through developmental studies, have worked to find procedures that get around discoloration, low penetration, and other problems associated with the use of aromatic resins. Later chapters will focus on these resins.

Marinelli (1975), aware of the low chemical resistance and poor mechanical properties of butanediol diglycidyl ether, recommended the tetraglycidyl ether of pentaerythritol, Araldite XB 2697, for stone consolidation. This material was offered as a 30-35% solution in acetone and water under the product designations XG 40 and LM 6121 by Ciba-Geigy. The solution had a viscosity of approximately 10 cP at 20 °C, a pot life of 2 to 3 hours under ambient conditions, and was readily diluted with water. For this resin, Marinelli described the use of two amines of undisclosed composition, a cycloaliphatic amine (XG-41), and an aromatic amine (XG-42). The system was evaluated using a homogeneous synthetic stone cast from plaster, white cement, sand, and water. Acetone-water solutions of the resin penetrated this stone easily and total impregnation of test blocks was achieved by brushing. Treated blocks were cured for 28 days at 20 °C and 65% relative humidity and, along with untreated specimens, were subjected to 25 cycles of immersion in sodium sulfate solution for 4 hours and drying at 60 °C for 20 hours (Tabasso et al. 1974). The blocks were then measured for compressive and mechanical strength. The results, summarized in Table 12, show that this treatment resulted in large increases in compressive and flexural strength and provided significant protection against the deterioration that is generally caused by salt crystallization. Whether the curing agent was an aliphatic amine or an aromatic amine made little difference in the mechanical properties. Treated blocks did turn yellow upon exposure to the ultraviolet radiation of a 300-watt Hanau quartz lamp, and the aromatic amine gave significantly poorer results. The color was removed by mild sandblasting or by wiping with solvent one day after application.

| Sodium Sulfate<br>Crystallization<br>Cycles | Flexural Strength <sup>a</sup> |                         |                        | Compressive Strength <sup>a</sup> |                         |                        |
|---|--------------------------------|-------------------------|------------------------|-----------------------------------|-------------------------|------------------------|
|   | Untreated <sup>b</sup>         | Aliphatic<br>Amine Cure | Aromatic<br>Amine Cure | Untreated                         | Aliphatic<br>Amine Cure | Aromatic<br>Amine Cure |
| 0   | 5                              | 62                      | 51                     | 14                                | 89                      | 78                     |
| 1   | 6                              | 24                      | 24                     | 14                                | 38                      | 42                     |
| 5   | 6                              | 26                      | 29                     | 6                                 | 41                      | 44                     |
| 20  | c                              | 11                      | 12                     | c                                 | 22                      | 24                     |

a. Values in kg/cm<sup>2</sup>.

b. Each value represents the average of ten determinations.

c. All specimens were destroyed by the seventh cycle.

Table 12. Mechanical properties imparted to synthetic stone by a resin based on pentaerythritol tetraglycidyl ether.

In Chapter 5, pentaerythritol resin was compared with other consolidants in field studies. In these studies, the resin was applied to weathered Bolognese sandstone surfaces without the use of solvent. This treatment gave poor penetration and severe discoloration, but after eight years, the treated stone resisted further deterioration better than stone treated with other types of consolidants. In limited laboratory studies with the same but freshly quarried sandstone, where the resin was applied in solvent, treatment gave good penetration and little discoloration (Rossi-Manaresi 1981).

The ability of pentaerythritol tetraglycidyl ether-derived resin to enable the cast stone to withstand many additional sodium sulfate crystallization cycles contrasts with the findings of Kotlik and others that butanediol-derived resins show poor resistance to hydrolytic or chemical attack. The instability of the butanediol product can be attributed to low hydrophobicity due to the high oxygen to carbon-hydrogen ratio of the molecule. The pentaerythritol compound is not very different, but its stabilizing properties may result from the high degree of cross-linking that can result with a tetrafunctional monomer. This can also lead to a more brittle product.

One manner of taking advantage of the properties that accrue to an aliphatic structure while avoiding chemical and hydrolytic instability is to use a larger, more hydrophobic molecule such as might be obtained by hydrogenating bisphenol A and reacting the cycloaliphatic diol with epichlorohydrin. The product, 2,2-di(4-hydroxycyclohexyl)propane diglycidyl ether, would have a 5.2:1 carbon to oxygen ratio compared to 2.1:1 for pentaerythritol tetraglycidyl ether. Material of this type is available commercially from the Shell Chemical Company as the Eponex series of epoxy resins (Bauer 1982). These compounds were introduced in 1977 and have found a substantial market in formulated coatings because of improved outdoor perfor-

mance over conventional bisphenol A-type resins and lower viscosity, which permits application at higher concentrations.

Eponex 1510 has a viscosity of only 2000 cP at 20 °C compared to 10,000 -16,000 cP for dimensionally similar, conventional bisphenol A epoxy resins. The improved light stability of this resin is demonstrated in Figures 9 and 10. The first figure describes results of exposing polymer films to a QUV cyclic ultraviolet tester, which accelerates oxidative degradation of the resin and leads to a faster decrease in surface gloss. The retention of this property by the Eponex resin shows the greater stability to ultraviolet radiation of coatings made from an aliphatic epoxy resin over those produced from bisphenol A. Figure 10 similarly compares the Eponex surface to two other polymers known to provide films of high stability to ultraviolet-induced autoxidation, i.e., an acrylic-urethane copolymer and a polyester-urethane copolymer. These copolymers began to exhibit deterioration after 1000 hours when placed in a Xenon arc Weather-Ometer, while the Eponex product required 2500 hours to show similar behavior.

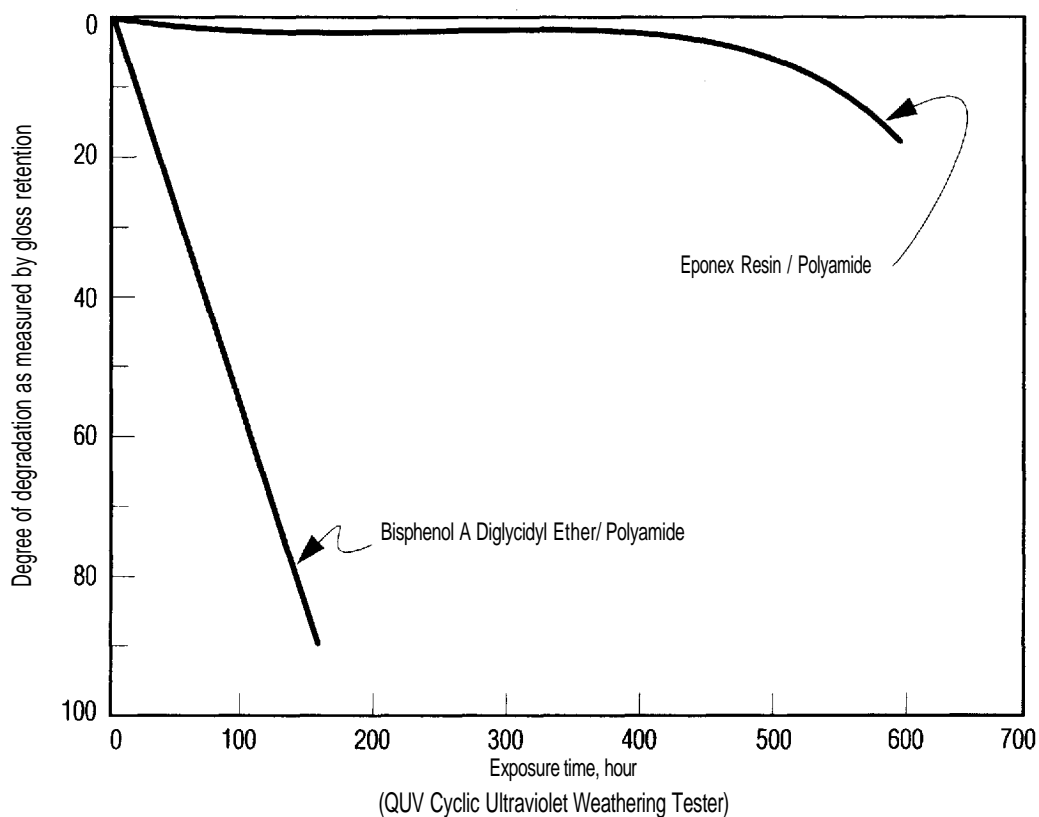

Figure 9. Comparison of the stability of cycloaliphatic and aromatic epoxy resins to ultraviolet radiation-induced autoxidation (courtesy of R. S. Bauer).

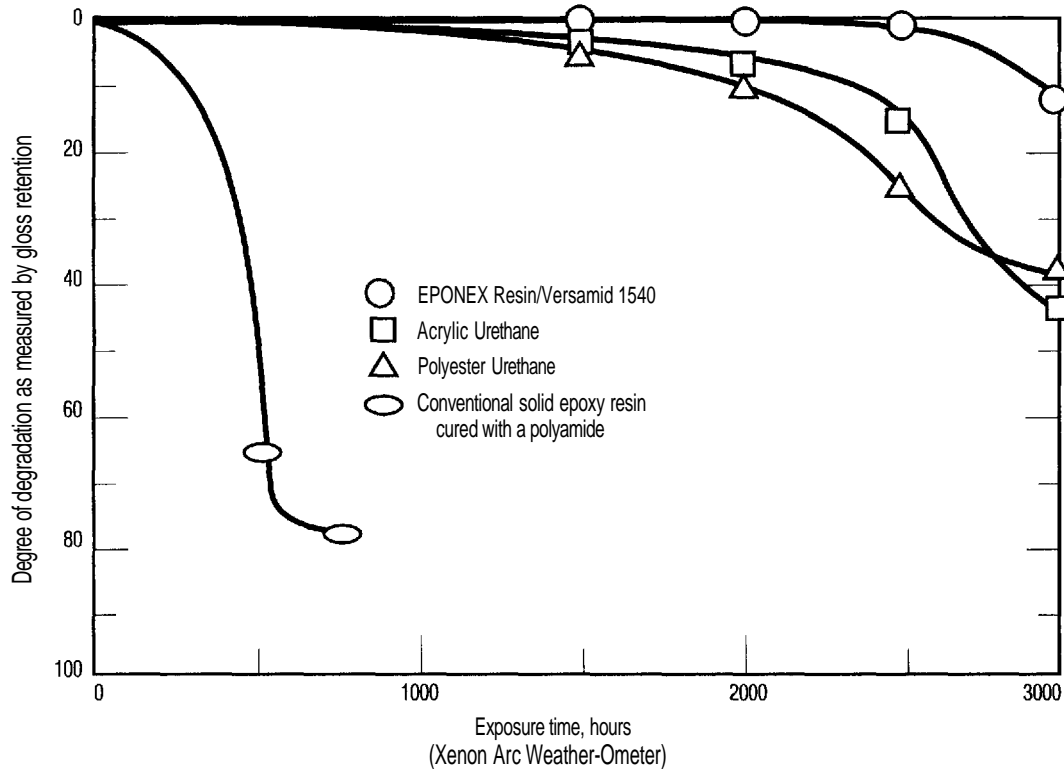

Figure 10. Comparison of the stability to ultraviolet radiation-induced autoxidation of cycloaliphatic epoxy resin to other resins of good stability (courtesy of R. S. Bauer).

These studies were done with polyamide-type curing agents, but even greater light stability and lower solution viscosities are obtained with the Jeffamine aminopoly-(oxypropylamine)s. Aliphatic resins are inferior to bisphenol diglycidyl ethers in two ways: Generally, they do not provide as great an improvement in mechanical strength as the aromatic types and they cure more slowly. However, the lower compressive and tensile strengths are still much higher than those provided by silanes or acrylic resins, but slow curing can be more of a problem. Eponex resins require about three times as long to harden than bisphenol derivatives and this must be taken into account when they are used. Since their introduction, weatherable epoxy resins based on hydrogenated bisphenol A have been successfully applied as clear coatings for wood, as a binder for decorative aggregate, and in many maintenance applications, but the literature does not mention their use for stone consolidation or other needs in art conservation.

More recently, Marinelli has developed a cycloaliphatic epoxy monomer of undisclosed structure designated EP 2101. This material has been used successfully in the field (Cavaletti et al. 1985, Fiori 1987) for the consolidation of granites, trachytes, limestones, marble, and synthetic stone. The development of EP 2101 at STAC, a small composites manufacturer in

Milan, represents a continuation of Marinelli's interest in finding an aliphatic epoxy monomer that avoids many of the problems associated with pentaerythritol tetraglycidyl ether. EP 2101 is used typically with an aliphatic polyamine, K 2101, in a 5:1 ratio, as a 25% by volume solution in an isopropanol-toluene co-solvent. This formulation has a working time of 24 hours at 20 °C and a pot life of 48 hours for 1 kg. A relatively long induction period, two to eight hours is recommended. Induction time is the period, after mixing and before application, when the epoxy monomer is allowed to react with active, usually primary, amine groups of the hardener to form a less active curing agent. This prevents the amine carbonate formation that would otherwise occur on exposure of the resin to the atmosphere. These factors suggest that K 2101 is similar to an aminopoly(ethyleneamine) such as triethylenetetramine.

Laboratory studies with EP 2101, primarily with marbles, limestones, and rocks of volcanic origin, included tests on color stability and improvement in compressive strength. The results are provided in Table 13. Polymer take-up, following partial or total immersion of five different types of stone, ranged from a low 0.15% for a decayed marly limestone to a substantial 6.0% for a deteriorated Viterbo tuff. Color stability was determined by color index measurements on all of the treated cubes after 500 hours of exposure to ultraviolet radiation ( $\lambda = 366 \mu\text{m}$ ) in a Fluotest chamber and 2000 hours in a Weather-Ometer. The excellent colorfastness of this resin was evident in consolidated white Chiampo limestone, Pietra de Vicenza limestone, and Proconessian marble. Several samples had a darkened wet appearance, while the tuff and the trachyte showed some change in tonality. When stone darkens following consolidation, it is usually because there is a change in the reflectance characteristics when the polymer fills the outer pores and cavities—not from the yellowing of the polymer. In contrast to the evaluation of stability of the Eponex resins (Figs. 9-10), these studies demonstrate the colorfastness of Marinelli's cycloaliphatic epoxy resin in the context of its application to stone. Both amine systems were compared to acrylic resins for color stability and were found to be similar or better. Table 13 also shows that treatment with an aliphatic epoxy resin provides substantial improvement in mechanical strength.

A comparative evaluation of EP 2101 with an acrylic polymer (Paraloid B-72) and a polysiloxane (DriFilm 104) was made to find the best consolidant for the treatment of deteriorated first-century floor mosaics from Nora, Sardinia (Fiori 1987). The mosaic pieces consisted largely of calcite with lesser amounts of granitic minerals. In order to evaluate the consolidants, synthetic cores of similar composition were made from slaked lime and granite ground to a particle size distribution comparable to that found in the floor mosaics. After treatment by total immersion in solutions of each consolidant, the cores were evaluated for water permeability and improvement in mechanical strength (Table 14). A comparison of the rate of capillary rise of water in treated and untreated stone showed that DriFilm was an effective water barrier, B-72 was ineffective, and the epoxy resin fell in between. However, epoxy resin provided the greatest improvement in strength.

| Stone  | Uptake Percent Weight Increase |                     | Discoloration After 500 Hours in a Fluotest Chamber $\lambda=366\mu\text{m}$ | Compressive Strength $\text{kg/cm}^2$ |                      |                             |
|--|--------------------------------|---------------------|--|---------------------------------------|----------------------|-----------------------------|
|  | By Immersion                   | By Capillary Action |  | Not Treated                           | Treated By Immersion | Treated By Capillary Action |
| Chiampo (Vicenza) limestone  |                                |                     | No change, comparable to B-72  |                                       |                      |                             |
| Pietrade Vicenza, a very porous fossiliferous limestone                    | 5.5                            | 3.9                 | No change  | 250                                   | 450                  | 440                         |
| Decayed Marmo Rossi de Verona marly limestone                              | 0.15                           |                     | Wet appearance   | 860                                   | 1500                 |                             |
| Proconessian marble  |                                | 0.78                | No change  |                                       |                      |                             |
| Decayed Viterbo tuff   |                                | 6.0                 | Increase in tonality <sup>a</sup>  |                                       |                      |                             |
| Euganean trachyte  |                                |                     | Increase in tonality   |                                       |                      |                             |
| Various unspecified marbles  |                                |                     | Wet appearance   |                                       |                      |                             |
| Marmo Troddense, a quartz monzonite artificially weathered by NaCl cycling | 0.21                           | 0.18                | Wet appearance   |                                       |                      |                             |

a. In field work there was an initial striking change in color that became less noticeable with time.

Table 13. Laboratory studies with a resin from a cycloaliphatic epoxy monomer (EP 2101) and an aliphatic polyimine (Cavaletti 1985).

Fiori also made some interesting findings on penetration and the interaction of resin and substrate by determining the pore size distribution after treatment, both at the center of the cylindrical specimen and near the surface. In the case of EP 2101, the intermediate pore sizes were eliminated to give a binodal pore size distribution, both at the surface and in the center. Thus, complete penetration was achieved. With the other consolidants, there was a small loss of the largest and smallest pores, but only in the outer portion of the sample. Complete penetration was not accomplished. These studies confirm that optimum penetration of resin is achieved when a resin with inherently low-viscosity properties is used in relatively high concentration. The authors concluded that EP 2101 was the consolidant of choice for their project.

| Consolidant                             | None | EP 2101 <sup>a</sup> | B-72 <sup>b</sup> | DriFilm 104 <sup>c</sup> |
|---|------|----------------------|-------------------|--------------------------|
| Polymer content in stone, weight %      | –    | 8.5                  | 5.0               | 3.0                      |
| Water Absorption <sup>d</sup>           | –    | 40-50                | 75-85             | 7-8                      |
| Compressive Strength kg/cm <sup>2</sup> | 25   | 69                   | 36                | 32                       |

a. 25% resin solution in isopropanol-toluene co-solvent.

b. 10% w/v solution of polymer in 67% acetone and 1,1,1-trichloroethane and 33% xylene and toluene,

c. 7%, w/v, solution of DriFilm 104 in 10% xylene and toluene and 90% acetone and 1,1,1-trichloroethane.

d. Percentage of capillary uptake relative to uptake by untreated samples.

*Table 14. Comparison of a cycloaliphatic epoxy resin with other consolidants for the stabilization of synthetic stone (Fiori 1987).*

A number of parts of statues and buildings with deteriorated stone have been treated by stone conservators in Italy using EP 2101. Field work with this resin began in 1983. A containment-type application procedure was developed in 1985 (Chapter 9) that provided deep penetration of the resin into limestone and simplified color control. Based on the excellent results achieved on structures in Italy, Lazzarini (1990) recommends the use of EP 2101 to restorers.





# 8 Solvent Effects in Resin Application

The use of solvents to lower epoxy resin viscosity makes it possible to use these polymers in stone consolidation and this requires that attention be given to the composition of the solvent system. Solvent composition most directly affects the reaction rate between the epoxy compound and the amine, and thus the curing rate, and the nature of the interaction of the resin components with surfaces of stones of different types. Additionally, solvent composition impacts on pot life, penetration, film formation, adhesion, color stability, gas permeability, and other properties critical to the performance of a stone consolidant.

The effect of solvent functional type on the curing rate has been well defined. Hydroxyl compounds, such as alcohols, act as catalysts and accelerate curing, but are not serious competitors with amines for reacting with the epoxide ring (Shechter et al. 1956). Water, functioning as a hydroxyl compound, accelerates the reaction even more than alcohols, while the addition of a phenol, a more acidic hydroxyl compound, can lead to a runaway reaction. Aprotic solvents such as aromatic hydrocarbons or mineral spirits have no effect on the amine-epoxy reaction and behave as inert diluents, while carbonyl compounds, like acetone and methyl ethyl ketone, retard the reaction.

Acceleration by the hydroxyl group is believed to be caused by the hydrogen bond interaction of this group with the oxirane oxygen that assists in its displacement by the amine (Equations 6-8), while inhibition by ketones results from reversible in situ ketimine formation which lowers the availability of amine groups (Equation 9). In this manner, the solvent composition can determine induction period, curing rate, and pot life. Figure 11 illustrates the effect of solvent composition on the pot life of a hydrogenated bisphenol A diglycidyl ether cured with a polyamide (Bauer 1982) and shows that viscosity buildup is much more rapid when the solvent is butanol than when it is methyl isobutyl ketone.

Equation 6.

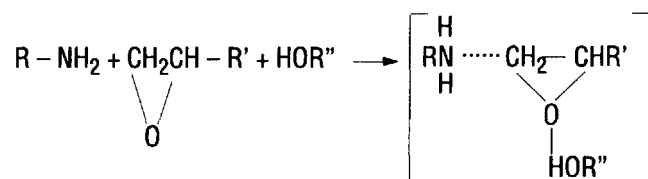

Equation 7.

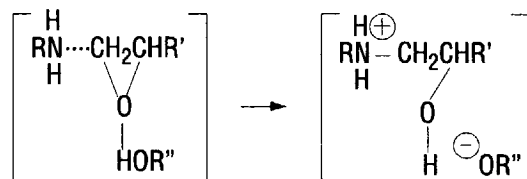

Equation 8.

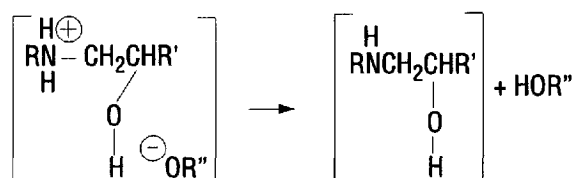

Equation 9.

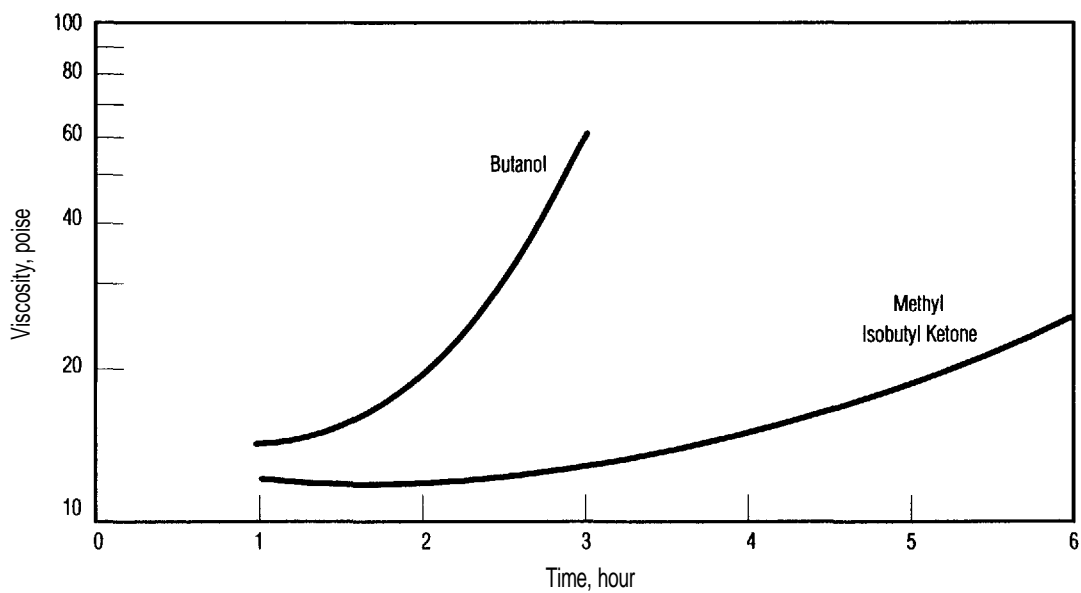
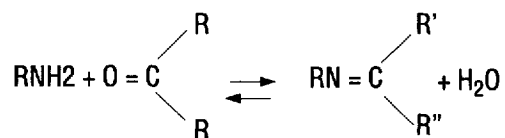

Figure 11. Effect of solvent functional type on the pot life of a hydrogenated bisphenol A diglycidyl ether/polyamide resin (courtesy R. S. Bauer).

| Solvent                       | Precipitation<br>% of resin |
|-------------------------------|-----------------------------|
| Cyclohexane                   | 0                           |
| Methyl ethyl ketone           | 0                           |
| Acetone                       | 0                           |
| Dioxane                       | 0                           |
| Benzene                       | 0                           |
| Xylene                        | 0                           |
| Xylene (95) and propanol (5)  | 0                           |
| Xylene (33) and propanol (67) | 70                          |
| Xylene (11) and propanol (89) | 85                          |

The resin consisted of 82 parts of bisphenol A diglycidyl ether (Epidian 5, Molecular weight = 370) and 18 parts of triethylenetetramine.  
 Resin concentration = 10%  
 Temperature = 17-18 °C  
 Time = 72 hours

Table 15. Effect of solvents on the precipitation of cured resin.

These factors were studied in the context of developing formulations for the treatment of stone by Domasłowski (1969) and Kotlik (1981). Domasłowski was concerned with providing the most suitable resin concentrations and solvent systems for the deep impregnation of Polish sandstones and limestones. However, before consolidation studies were attempted, he examined the use of a wide range of solvent blends with bisphenol A diglycidyl ether and triethylenetetramine to determine the effect of variables such as resin molecular weight and concentration, solvent type, solvent ratios and the addition of water on curing rate and on whether the polymer would remain as a film as the solvent evaporated or would precipitate from solution. Precipitation is preferable because migration of resin back to the surface is prevented when solvent is eventually allowed to escape, and it produces a consolidant film less prone to cracking. The effect of solvent type was demonstrated in experiments where 10% solutions of bisphenol A diglycidyl ether triethylenetetramine resin in different solvents were allowed to cure at 17-18 °C for 72 hours (Table 15). No precipitate formed in solutions based on cyclohexane, acetone, dioxane, xylene, or xylene containing 5% propanol. However, at high propanol-to-xylene ratios, most of the cured resin precipitated, and this was found to be true of most alkylaromatic hydrocarbon-alcohol solvent combinations. Based on this finding, Domasłowski selected methanol and toluene as his co-solvents to investigate the effects of stone type and porosity, resin concen-

tration, and method of application on the penetration of resin and the quality of consolidation. The curing rate was found to increase slightly as epoxy monomer molecular weight increased and significantly more as the concentration of resin increased (Table 16). The more rapid increase in viscosity after 5 hours indicates the onset of gelation.

| Molecular Weight <sup>a</sup> | Concentration <sup>b</sup> Weight % | Degree of Curing <sup>c</sup> |    |    |
|-------------------------------|-------------------------------------|-------------------------------|----|----|
|                               |                                     | Time, hours                   |    |    |
|                               |                                     | 1                             | 5  | 9  |
| 370                           | 10                                  | 48                            | 52 | 54 |
| 370                           | 20                                  | 53                            | 59 | 79 |
| 1100                          | 10                                  | 51                            | 54 | 57 |
| 1100                          | 20                                  | 61                            | 67 | 87 |

a. The solvent consisted of 33% toluene and 67% butanol.

b. Values represent viscosity comparisons as determined by rate of outflow from a viscometer.

c. The resin consisted of 82 parts of bisphenol A diglycidyl ether (Epidian resins) and 18 parts of triethylenetetramine.

Table 16. Effect of resin concentration on the rate of curing.

| Curing Time, Days | Relative Amount Precipitated |      |       |       |
|-------------------|------------------------------|------|-------|-------|
|                   | Concentrations A/B           |      |       |       |
|                   | 2.5/96                       | 5/92 | 10/86 | 20/75 |
| 2                 | 36                           | 63   | 78    | 88    |
| 3                 | 49                           | 70   | 82    | 92    |
| 5                 | 59                           | 78   | 86    | 94    |
| 9                 | 74                           | 84   | 92    | 94    |

Bisphenol A diglycidyl ether, MW = 1100 (Epidian 4) 87%.

Triethylenetetramine 16%, 17-18 °C.

A is the concentration of resin in solution.

B is the concentration of methanol in the toluene-methanol co-solvent.

Table 17. The effect of curing time, methanol concentration, and resin concentration on the degree of polymerization.

Since increasing either resin or methanol concentration promoted faster curing, Domaslowski attempted to show that these factors could be balanced to achieve the same cure time at any resin concentration. Table 17 provides results of experiments where the amount of methanol was decreased to slow the cure rate while the resin concentration was increased. At best, this tuning was only partially successful. In this study, doubling the resin concentration to increase the reaction rate, tended to overwhelm the attendant decreases in methanol concentration as a factor for slowing the rate. However, other experiments indicated how these concentrations could be balanced to maintain a given time for the onset of precipitation. The blending of 30% resin in a 33% toluene and 67% methanol co-solvent led to polymer precipitation in 9 hours (Table 18). When the concentration of resin in this co-solvent was only 5%, precipitation time increased to 39 hours. However, by raising the alcohol to 87% the time before precipitation was brought back down to 9 hours. The replacement of the aminopoly(ethyleneamine) with an amidoamine at 50% of epoxy monomer, but otherwise on a comparable basis, led to precipitation times that were 25 to 100% longer. The addition of water to the solvent was found to reduce the amount of precipitation (Table 19).

| Concentration of resin in solution, Weight % | Concentration of methanol in toluene-methanol co-solvent, Volume % | Time to precipitation of resin <sup>a</sup> , hours |                       |
|--|--|---|-----------------------|
|  |  | Triethylenetetramine <sup>b</sup>                   | Versamid <sup>c</sup> |
| 5  | 67   | 39  | 77                    |
| 5  | 87   | 9   | -                     |
| 30   | 50   | 12  | 16                    |
| 30   | 67   | 9   | -                     |

a. The epoxy monomer was bisphenol A diglycidyl ether of molecular weight equal to 370 (Epidian 4)

b. Triethylenetetramine was 16% of resin.

c. Versamid was 50% of resin.

Table 18. Effect of resin and methanol concentrations on the length of time before polymer precipitation begins.

| Concentration of Water in Solution, Weight % | Amount of Resin Precipitation, % |
|--|----------------------------------|
| 0  | 80                               |
| 2.4  | 77                               |
| 4.7  | 75                               |
| 9.4  | 73                               |

The basic formulation consists of xylene - 30%, propanol - 60%, bisphenol A diglycidyl ether (Epidian 1, molecular weight = 1100) - 9.4% and triethylenetetramine - 0.6%.

Temperature = 30 °C

Time = 3 days

Table 19. The effect of the addition of water on the solubility of cured resin when using a xylene-propanol co-solvent.

Since the type of stone affects the ease and depth of penetration as well as the quality of stabilization, it was important to extend these findings to tests on stone. In studies with high- and medium-porosity sandstone and two limestones of relatively high open-pore volume (Table 20), it took one to two orders of magnitude more time for epoxy resin solutions to rise by capillary action in limestone than in the sandstones. Unfortunately, no data on pore size distributions were provided. The faster capillary rise in sandstone in comparison to limestone was true for both untreated stone and stone that had previously been impregnated with a 10% epoxy resin solution and for high and low concentrations of resin. This again showed that sandstone is generally easier to consolidate than limestone. The concentration of resin is an important factor in the quality of stabilization. Better results are obtained at higher concentration (Table 21). This is explained by the deposition of larger amounts of polymer, which can also be accomplished by the use of multiple applications at lower concentrations, and also by the greater penetration caused by the use of higher concentrations (Fig. 4).

| Stone Type           | Free Pore Volume, % |                     | Resin Concentration, weight % | Time for Capillary rise, Minutes <sup>b</sup> |                     |       |                     |
|----------------------|---------------------|---------------------|-------------------------------|---|---------------------|-------|---------------------|
|                      | Fresh               | Coated <sup>a</sup> |                               | 5cm   |                     | 15cm  |                     |
|                      |                     |                     |                               | Fresh   | Coated <sup>a</sup> | Fresh | Coated <sup>a</sup> |
| Sandstone Nietulisko | 22                  | 18                  | 5                             | 1.5   | 3.0                 | 24    | 32                  |
|                      | 22                  | 18                  | 20                            | 3   | 5                   | 48    | 69                  |
| Sandstone Zerkowice  | 14                  | 12                  | 5                             | 6   | –                   | 68    | 110                 |
|                      | 14                  | 12                  | 20                            | 11  | –                   | 135   | 154                 |
| Limestone Welcz      | 28                  | 23                  | 5                             | 51  | 138                 | 783   | –                   |
|                      | 28                  | 23                  | 20                            | 88  | –                   | 742   | –                   |
| Limestone Pinczow    | 30                  | 25                  | 5                             | 50  | 113                 | 365   | –                   |
|                      | 30                  | 25                  | 20                            | 116   | –                   | –     | –                   |

- a. "Coated" refers to treatment of stone with a formulation consisting of bisphenol A diglycidyl ether (Epidian 4, molecular weight equal to 390) - 8.4%, triethylenetetramine -1.6%, toluene 30%, and methanol 60% prior to capillary rise experiments.
- b. Capillary rise experiments were done with a resin consisting of 84% Epidian 4 and 16% triethylenetetramine in a 2:1 methanol: toluene co-solvent.

Table 20. Effect of resin concentration on capillary rise of solutions in fresh and coated sandstone and limestone.

Table 21 shows improvements in mechanical properties measured by increases in compressive strength, after the Polish sandstones and limestones were impregnated with resin at low concentrations. Compressive strengths were also determined on sets of treated blocks after immersing them in water for 48 hours and after a single freeze-thaw cycle. Treatment of each stone type generally provided substantial improvements in strength in each of the three evaluation categories. While larger increases in compressive strength were demonstrated by the sandstones, the relatively weaker limestones may have received a more critical and important strengthening.

| Stone Type           | Resin Concentration in Solution <sup>a</sup> | Free Pore Space % | Compressive Strength Values, kg/cm <sup>2</sup> |                                       |                             |
|----------------------|--|-------------------|---|---------------------------------------|-----------------------------|
|                      |  |                   | Resulting from Treatment                        | After Immersion in Water for 48 hours | After One Freeze-Thaw Cycle |
| Sandstone Nietulisko | Untreated                                    | 22                | 149   | 161                                   | 148                         |
|                      | 5  | 26                | 273   | 268                                   | 228                         |
|                      | 30   | 13                | 484   | 356                                   | 423                         |
| Sandstone Zerkowice  | Untreated                                    | 14                | 373   | 336                                   | 234                         |
|                      | 5  | 13                | 469   | 420                                   | 317                         |
|                      | 30   | 5                 | 684   | 586                                   | 471                         |
| Limestone Welcz      | Untreated                                    | 28                | 98  | 56                                    | 62                          |
|                      | 5  | 25                | 169   | 99                                    | 119                         |
|                      | 30   | 11                | 379   | 262                                   | 317                         |
| Limestone Pinczow    | Untreated                                    | 30                | 110   | 52                                    | 53                          |
|                      | 5  | 26                | 192   | 134                                   | 30                          |
|                      | 30   | 19                | 348   | 233                                   | 33                          |

a. The resin solution consisted of Epidian 4 and triethylenetetramine in toluene and methanol at a 1:2 ratio.

Table 21. Effect of epoxy resin<sup>a</sup> concentration in the improvement in the resistance of sandstone and limestone to the forces of deterioration.

Kotlik and his coworkers (1981) expanded on the Domaslowski findings by recognizing that an additional factor affecting the barrier properties of the consolidant is the character of the solid eventually left in the stone, i.e., whether it is a film that forms and remains as solvent evaporates or is a binder deposited by precipitation. In the former case, extensive cracking of the deposited solid often occurs as cross-linking and volume contraction continue. Which of these paths the consolidation takes is determined largely by the nature of the solvent.

Kotlik studied the polymerization of bisphenol A diglycidyl ether with both an aminopoly(ethyleneamine) mixture containing predominantly diethylenetriamine and a more active fatty acid amide of aminopoly(ethyleneamine)s (Aminoamid D 500) in seven different solvent types and three co-solvent mixtures. The greater activity of Aminoamid D 500 suggests that it is a derivative of higher aminopoly(ethyleneamine)s. A typical study is shown in Figure 13



where the development of viscosity with time is plotted for the reaction of the epoxy monomer with each curing agent in four different solvents: xylene, butyl acetate, acetone, and cyclohexanone. Viscosity was determined by the rate of descent of a steel ball in a column of solution being measured. To exclude any effect of column geometry, the viscosity was presented as the descent time relative to an initial descent time according to Equation 10 where  $T_0$  is the time of fall of the ball immediately following the mixing of solution, and  $T$  is the value after some reaction time.

Equation 10.

$$\text{Viscosity} = T/T_0$$

In all solvents, a period of relatively slow viscosity buildup occurs, which is followed by a very rapid thickening. There is an initial formation of oligomers that has minimal effect on viscosity. The oligomerization does not continue to provide long, unbranched macromolecules because the amines are multifunctional and soon become involved in cross-linking. This leads to a three-dimensional structure, a sharp increase in viscosity, and, in some solvents, precipitation. The time required to achieve a tenfold increase in viscosity,  $T_{10}$ , is shown graphically in Figure 13 and is used as a measure of the effect of solvent on the rate of condensation. The figure shows that in each case the Aminoamide at 40 parts per hundred of epoxy monomer produces a faster cure than the aminopoly(ethyleneamine), which is used at only 10 parts per hundred. Reaction with either amine type takes much longer to reach  $T_{10}$  when the solvent is a carbonyl compound like acetone or cyclohexanone than when it is an aromatic hydrocarbon or an ester.

A rundown of the effect of the seven solvents and three co-solvent blends on the time for a tenfold increase in viscosity, on whether precipitation occurs, and on the color of the cured resin is provided in Table 22 for experiments where the curing agent was the aminopoly(ethyleneamine) mixture. The table also provides information on the impact of resin concentration and variations in the alcohol-alkylaromatic co-solvent ratios. The authors agree with Domaslawski that alcohol-alkylaromatic hydrocarbon mixtures are the most suitable solvents for epoxy resins destined for stone applications, but favor ethanol over methanol as a blending agent with toluene because it is less volatile and less toxic, and it allows more control over whether the resin remains dissolved or precipitates. The absence of color was most noticeable in the co-solvent systems. Results were similar when the amine cross-linking agent was Aminoamid D 500 except that reaction was generally faster and there was more color than was obtained with the use of the aminopoly(ethyleneamine) (Table 23).

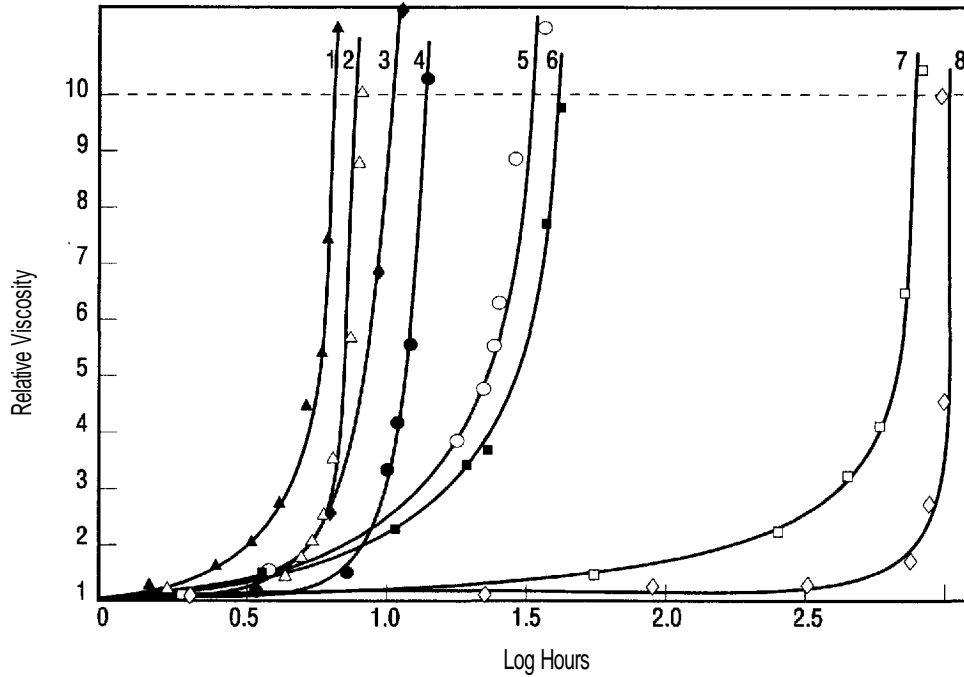

1. Xylene, Aminoamid D 500
2. Xylene, P1
3. Butyl acetate, Aminoamid D 500
4. Butyl acetate, P1
5. Cyclohexanone, Aminoamid D 500
6. Acetone, Aminoamid D 500
7. Acetone, P1
8. Cyclohexanone, P1

a. The resin consisted of 100 parts of bisphenol A diglycidyl ether, molecular weight = 450, with 40 parts of Aminoamid D 500 or 10 parts of P1, a mixture of technical grade aminopoly(ethyleneamine)s consisting primarily of diethylene-triamine. The treating solution was made up of 60 parts of resin and 40 parts of solvent.

Figure 13. Dependence of relative viscosity of epoxy resin solutions<sup>a</sup> on time (Kotlik 1981).

| Solvent                   | Resin Concentrate <sup>a</sup> | T <sub>10</sub> <sup>b</sup> Hours | Occurrence of Precipitate | Color                    |
|---------------------------|--------------------------------|------------------------------------|---------------------------|--------------------------|
| Cyclohexanone             | 60                             | 1180                               | No                        | Yellow                   |
| "                         | 80                             | 841                                | No                        | Transparent yellow brown |
| Acetone                   | 68                             | 866                                | No                        | Transparent yellow brown |
| "                         | 80                             | 850                                | No                        | Transparent yellow brown |
| Butyl Acetate             | 10                             | c                                  | Yes                       | Whitish                  |
| "                         | 60                             | 15                                 | Yes                       | White                    |
| Tetrahydrofuran           | 30                             | c                                  | Yes                       | Whitish                  |
| "                         | 60                             | 38                                 | Yes                       | Light yellow             |
| Xylene                    | 20                             | c                                  | Yes                       | Colorless                |
| "                         | 80                             | 3.2                                | Yes                       | White                    |
| Carbon tetrachloride      | 25                             | d                                  | No                        | Orange-brown             |
| Chloroform                | 40                             | 15.9                               | No                        | Transparent yellowish    |
| Methanol 90<br>Toluene 10 | 40                             | d                                  | Yes                       | Transparent white        |
| Methanol 50<br>Toluene 50 | 40                             | 7.1                                | No                        | Colorless                |
| Methanol 5<br>Toluene 95  | 40                             | d                                  | Yes                       | Transparent white        |
| Ethanol 95<br>Toluene 5   | 40                             | 5.0                                | Yes                       | Transparent white        |
| Ethanol 50<br>Toluene 50  | 40                             | 11.5                               | No                        | Transparent colorless    |
| Ethanol 5<br>Toluene 95   | 40                             | 18.7                               | Yes                       | White                    |

a. Resin consisted of 100 parts of bisphenol A diglycidyl ether, molecular weight equal to 450 and 10 parts of a mixture of technical grade aminopoly(ethyleneamine)s consisting primarily of diethylenetriamine.

b. T<sub>10</sub> is the time over which viscosity increases to ten times the initial value.

c. Rapid precipitation, before reaching T<sub>10</sub>.

d. No data.

Table 22. The effect of solvent on the buildup of viscosity and the precipitation and appearance of polymer with a bisphenol A diglycidyl ether-diethylenetriamine resin<sup>a</sup> (Kotlik 1981).

| Solvent                    | T <sub>10</sub> <sup>b</sup> Hours | Occurrence of Precipitate | Color       |
|----------------------------|------------------------------------|---------------------------|-------------|
| Acetone                    | 49                                 | No                        | Yellow      |
| Cyclohexanone              | 40                                 | No                        | Yellow      |
| Tetrahydrofuran            | 26                                 | No                        | Yellow      |
| Butyl Acetate              | 10.5                               | Yes                       | White       |
| Xylene                     | 7.4                                | Yes                       | White       |
| Ethanol 50%<br>Toluene 50% | 5.6                                | No                        | Yellow      |
| Ethanol 90%<br>Toluene 10% | -                                  | Yes                       | White       |
| Cresol 50%<br>Xylene 50%   | 0.9                                | No                        | Dark Yellow |

a. All studies were done with 60% resin in solvent. The resin consisted of 100 parts of bisphenol A diglycidyl ether and 40 parts of Aminoamid D 500.

b. T<sub>10</sub> is the time over which viscosity increases to ten times the initial value.

Table 23. Effect of solvent on the buildup of viscosity and the precipitation and appearance of polymer with a bisphenol A diglycidyl ether-fatty acid amide resin<sup>a</sup> (Kotlik 1981).

This study (Table 23) has not provided a fundamental understanding of how deposition of binder by evaporation, in contrast to precipitation, affects the quality of consolidation in the property categories important for long-term stone stabilization, such as improvement in mechanical strength, water repellency, resistance to chemical attack, and stability to color change. It would be helpful to compare of stone impregnated with acetone solutions, which favor film formation, against substrates treated with co-solvent solutions, which yield polymer by precipitation, after extended aging studies. Even better might be research using different, more probing methods of examination, such as the use of an environmental scanning electron microscope.

# 9 Application Procedures

How deep a consolidant penetrates depends in large part on the method of application. Gauri (1970) reports satisfactory consolidation by brushing and spraying, although most preservationists working with epoxy resin solutions generally achieve penetration no deeper than 1 cm using these procedures. Gauri's success may be attributed to the type of stone he has treated. His best results were obtained with structures made of cast, synthetic stone, like the California Building in San Diego (Gauri 1978). These castings were made from a quartzose aggregate of fine granules and coarse sand bonded by a lime cement. The physical properties are similar to those of a highly porous, large-grained sandstone that has weathered deeply, in a manner expected of a calcite cemented product. In fact, the unique chemical and structural composition of this stone provides a lower surface energy under treatment than does natural stone, which allows a more facile transport of the solvent. Also, Gauri uses acetone, which is a more powerful eluant than alcohol-aromatic hydrocarbon mixtures, and this property may aid in achieving the deep penetration he obtains with brushing and spraying.

## Pocket Methods

Applying resin to limestone or even sandstone by brushing generally does not achieve good results. Putting a thin coat of resin solution on a vertical surface does not provide the pressure, nor is there enough time of contact to obtain deep penetration in nonreceptive stones.

Domaslowski (1969) found that good penetration can be achieved by maintaining a large area of liquid against a stone surface. Figure 14 illustrates experiments where pockets of different sizes were attached to one side of upright slabs. Studies using water showed that as the contact area provided by the pocket increases, penetration is greater, and the time needed to get sizeable amounts of liquid into the stone decreases sharply. Rapid wetting through 5 cm of stone is a good indication of the power of the pocket method to provide deep consolidation (Table 24).

| Absorption Area, cm | Time to Reach Back of Slab, min | Time to Saturate Slab, min |
|---------------------|---------------------------------|----------------------------|
| 18 x 18             | –                               | 3                          |
| 10 x 10             | 2                               | 7                          |
| 2 x 2               | 7                               | 75                         |

Stone size = 20 x 20 x 5 cm

Table 24. The influence of the absorbing surface area on the rate of total saturation of a vertical building stone with water.

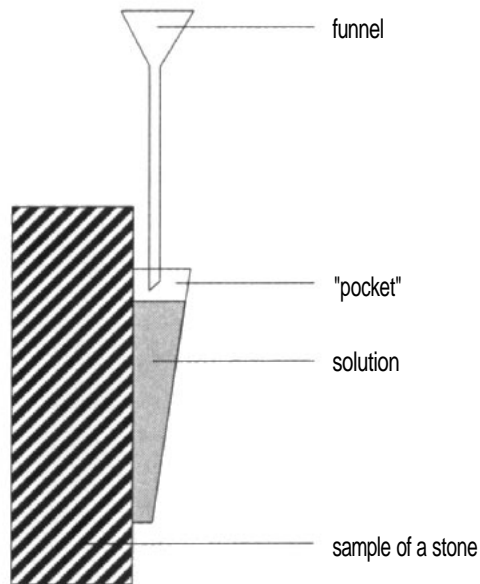
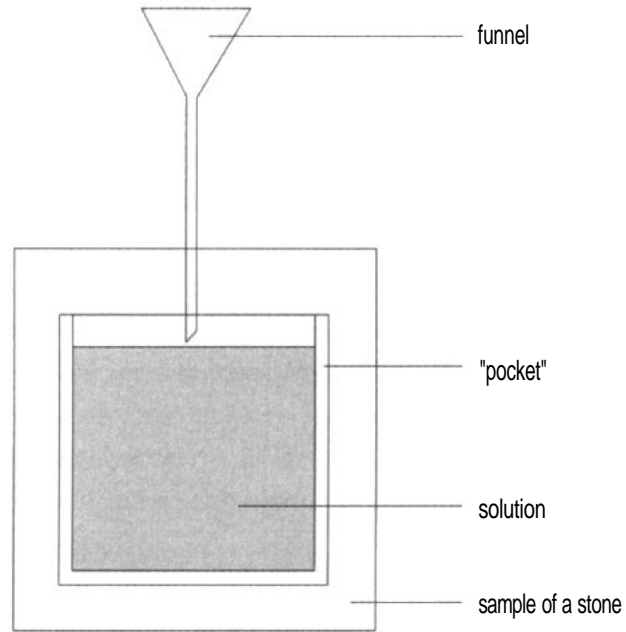

Figure 14. Saturation of stone by consolidant using the pocket method (Domaslawski 1969).

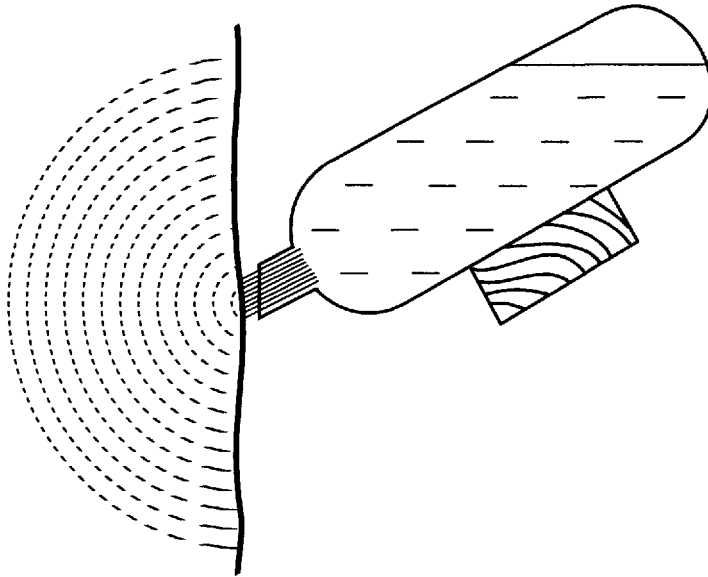

Figure 15. Small contact area with bottle impregnation.

Mirowski (1988) proposed a standing liquid procedure that impregnated stone through a large number of small contact areas as shown in Figure 15. The consolidant was supplied by a series of movable, 50-mm polyethylene vessels through a foamed polyurethane contact piece placed against bare rock which spread the consolidant through the stone as contiguous hemispheres. Vacuum release allows liquid to flow from the vessel only as long as there is uptake. Mirowski recommended the use of plastic film to deter the evaporation of solvents. This procedure would appear to be in conflict with Domaslowski's conclusion that the contact area should be as large as possible. Mirowski has suggested that the procedure could be modified by first covering the object with a cellulose poultice. However, it was found that while this enabled the surface to be impregnated much more rapidly and completely, the treatment was cumbersome and wasted consolidant.

The pocket method was employed by Domaslowski (1967) for the consolidation of weathered sandstone in field projects, and epoxy resin solutions easily penetrated 7-10 cm into the substrate.<sup>1</sup> His treatment of a portal of the historic Eskens House in Torun, Poland provides the first field example of the pocket method. This extensively deteriorated sixteenth-century structure was laminar gray sandstone of 13% open porosity with clay and calcareous binders. The portal was highly sculpted, partially polychromed, and covered with four layers of oil paint which were responsible for some of the deterioration.

After preconsolidation, which is described in Chapter 10, removal of the paint layer, and desalination, treatment of the portal was carried out by two slightly different pocket procedures. The flat surfaces happened to be consolidated during warm weather (28 °C). On

these surfaces, 16-cm-high pockets of cellophane film were fastened to the wall with a paste made of powdered chalk, poly(vinyl alcohol), and water. The pockets were laid out in rows with the lower rows overlapping those preceding. It was important not to leave spaces between the pockets, which would allow formation of an undesirable resin crust. The consolidation formulation, 10% Epidian 5 and 1.2% triethylenetetramine in 4:1 methanol-toluene, was designed to achieve deep penetration at 28 °C in six to eight hours. The pockets were kept filled, and after a few hours the stone stopped taking up solution and resin was seen to precipitate. At this point, the solution was removed, the pockets were rinsed with solvent, and the surface was covered with film to close the pockets. A total of 91 liters of epoxy solution had been applied over 7.5 m<sup>2</sup>, and the penetration was 9-10 cm. After 10 days the film and the pockets were removed. The surface was immediately cleared of poly(vinyl alcohol) by washing with hot water to complete the treatment.

A different pocket procedure was used on carved stone surfaces where the film could not be securely attached. Water saturated paper pulp was packed into the cavities and contours of the stone. When this dried, it was coated with chalk paste and then gypsum. All pockets were tested with toluene-methanol to find leaks, which were then sealed with more gypsum. This phase was carried out when the average temperature was near 17 °C. The formulation required a 5:1 methanol-to-toluene ratio to increase the curing rate at the lower temperature, and the transport of solution into the stone was also slower. After 7 hours there was no further absorption of solution but it was maintained against the stone for an additional 12 hours. The pockets were then removed, the surface was rinsed with solvent and covered with cotton wadding soaked with solvent, then wrapped tightly with cellophane film. The stone was uncovered after 10 days, but more time should have allowed. Curing was incomplete at the lower temperature, and the resin components subsequently migrated to the surface and caused some darkening. Penetration into the curved surfaces did not exceed 6 or 7 cm because the pores were often clogged with paint, and leakage from the pockets made it difficult to keep the liquid against the stone.

Another example of the pocket method of consolidation is the hallowed stone portal of the St. Mary Magdalene Church in Wroclaw, which dates back to the earliest period of Christianity in Poland and has long been an object of concern for stone conservators in that country (Domaslowski 1970). The sandstone structure has a clay-calcite binder and has suffered gradual and extensive erosion and deterioration over time. Consolidations with fluorosilicones, ethyl silicate, paraffin, asphalt, and undisclosed organic polymers have kept some localized problems under control, but have hastened deterioration in other parts of the archway. The most recent intervention was done in 1967-68 (Domaslowski 1970). The portal was first preconsolidated, cleaned, and desalinated. Pockets were created by placing semi-cuplike configurations of sheets of wet paper against the sandstone surface. Several layers of gypsum-



sand (2:1) mortar were applied over each pocket and beyond the edges of the two sides and the bottom, while the top edge was pulled open to create a receptacle for the epoxy solution. A network of these pockets was arranged to cover the portal's surface. After the mortar dried, the network was tested with solvent to locate and seal leakage points. Deep impregnation was achieved by keeping the pockets filled with the consolidating solution for the duration of the treatment. Subsequently, the pockets were removed, and before the epoxy resin had a chance to harden, the stone was scraped free of mortar and polymer. The portal was then wrapped in film for 10 to 40 days. For this project 390 liters of 10% epoxy resin solution (Epidian-5, 8.5; triethylenetetramine, 1.5; toluene, 22.5; methanol, 67.5) were used. After accounting for handling losses and absorption by pocket material it was determined that 295 liters were put into the stone and this was calculated to provide an average depth of penetration of 7.4 cm. If the stone had not previously been treated, the impregnation would have been much deeper. Finally, the consolidated stone was again desalinated to remove any salts introduced by the gypsum-based mortar.

These structures were examined independently by stone conservators in 1972 (Domaslowski and Strzelczyk 1986) and in 1986 (Wheeler 1990) and all indicated that no signs of deterioration, such as powdering, exfoliation, or peeling, were observed. The stone showed good mechanical resistance and the treatment did not cause any striking variation of appearance.

## Bulk Procedures

While the pocket method achieves remarkable depths of penetration, it is a cumbersome procedure that has not seen much further use. The pockets are difficult to prepare, they leak, and they leave marks on the surface that must be patched. A more convenient procedure was developed by Domaslowski and used on a Renaissance doorway and portal in Torun. He glued vertical strips of porous wicking material (initially soft paper, but later cellulose wadding) to the stone with a 2% solution of methyl cellulose and covered them with polyethylene film. The wadding strips hung out over the top of the area being treated and they were put into reservoirs of epoxy solution, which were positioned near the top of the structure. The resin solution was absorbed up into the tongues of wadding and ran down against the stone surface. Some of the resin impregnated the stone, and the remainder collected in drainage tanks to be recycled.

With experience in handling the wood frames and large polyethylene sheets, very effective coverage was achieved, which prevented solvent loss during the 5 1/2 hours needed for impregnation and over the 10 days needed to get a critical degree of curing. One hundred liters of 15% solution were required for each of the two large sandstone Renaissance doorways and penetration averaged over 7 cm. Obviously, this procedure is more cumbersome than brushing, but it was also used in the restoration of a deteriorating sandstone statue of St. Francis



a



b

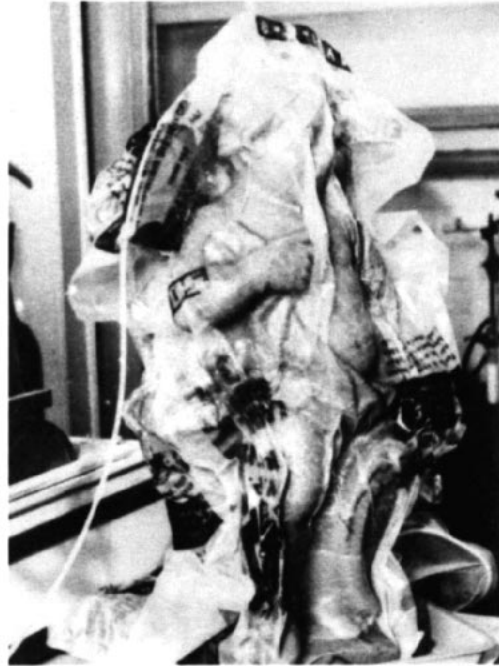

c

Figure 16. Reduced pressure impregnation of sandstone angel, (a) Angel before treatment, (b) Sculpture wrapped in netting, (c) Sculpture during impregnation (Kotlik 1990).

in Klodzke, Poland. This statue was wrapped with cellulose wadding and then with polyethylene sheets to prevent premature evaporation of solvent. The consolidating solution was supplied to the statue through wadding that extended down into a tank containing 10% Epidian 5 and 1.2% triethylenediamine in a methanol-toluene co-solvent.

Kotlik (1990) has used Domaslowski's recommendations on solvents in his own developmental research on penetration procedures and the effect of resin concentration to carry out the restoration of a number of small statues. An example is his treatment of an angel in a small town in northern Bohemia. The statue is 1.3 m tall and is cut from poor quality sandstone (Fig. 16a). It was wrapped with polyethylene netting (Fig. 16b) and then placed in a tight-fitting 2 mil-polyethylene sheath. Welded into the sealed top and bottom of this chamber were polyethylene tubes 1 cm in diameter. Inside the chamber, these tubes were placed into short rigid sleeves of polyvinyl chloride tubing, 4 cm in diameter with holes along the periphery. This arrangement kept the polyethylene tubes open during the vacuum process. The upper tube was connected to a vacuum pump, while the lower one dipped into a reservoir of epoxy resin solution. Initially, the vacuum applied to the top polyethylene tube lowered the pressure to 15 mm Hg. The plastic film was pressed against the sandstone, but the netting helped maintain space for the rising epoxy solution (Fig. 16c).

Before working on the statue, Kotlik treated a sample of the same stone. The formulation was based on a 450 molecular weight bisphenol A diglycidyl ether (CHS Epoxy-15), which is the lowest molecular weight resin of that type produced in Czechoslovakia. It consisted of 35 parts by weight of CHS Epoxy-15, 3.5 parts of diethylenetriamine, 46.5 parts of ethanol and 18.5 parts of toluene. The trial stone showed an 8.2% weight gain before drying and the depth of penetration ranged from 5 to 30 mm. The evaporation of the solvent took several months. This is typical of solvents containing aromatic hydrocarbons. After these tests, the impregnation of the angel was carried out. Resin solution was sucked in to fill up the bag over a three-hour period and the vacuum was kept at 55 mm Hg for an additional three hours. During this period, some solvent was drawn off and the solution viscosity rose. When the impregnation was finished, the surplus solution was drained, the chamber was removed, and the statue was wrapped in thin polyethylene film to prevent evaporation of solvent and back migration of the polymer during the final cross-linking period. The statue was reinstalled after ten weeks, and two years later it showed no deterioration. Despite Kotlik's objections, the statue was painted making it impossible to see if the resin was discoloring. Other smaller statues treated in a similar manner have developed a yellowish tinge after six years, but there was no indication of further degradation.

A modification of these methods was later developed by Lazzarini, using the cycloaliphatic resin EP 2101, and was employed by the Restoration Working Society of Cartura to treat several important stone monuments in Italy. Most of these structures were limestone, which is relatively difficult to treat, and had deteriorated in a manner that required the rebuild-

ing of mechanical strength. Lazzarini found that even with a less viscous aliphatic formulation, application by brushing did not provide the control and penetration needed for complete consolidation. His new procedure consisted of building a container around the object and filling it with solution. The container was constructed of wood, plastic film, or any other suitable material and was usually filled with cotton wadding. When the consolidating solution was poured into the chamber, the cotton became saturated with the solution and maintained the consolidant against the stone surface for enough time to provide good penetration. After the resin components had cross-linked to the point where the solution became gelatinized in the chamber, the container and the wadding were removed. At this point, the semisolid resin was easily removed by brushing. The restorers found that this procedure provided very satisfactory impregnation and no further cleaning was required. However, a large amount of consolidant was lost with the discarded wadding. This procedure, using aliphatic epoxy resins, appears to be the best general method for consolidating statuary and structural artifacts of small to moderate size (Fig. 2).

### Notes

1. Details of the techniques involved in the pocket method are provided in two of his publications.
2. Photographs of the monument before and during treatment are provided in the book *Stone Decay and Conservation* (Amoroso and Fassina 1983).

# 10 Field Results

The ultimate test of findings from laboratory research and developmental studies is the application of the results to real problems. But in the absence of a history of using epoxy solutions for stone consolidation, early projects are unique and are therefore exercises in research. This is most clearly seen in the evolution of application methods in field projects.

European conservators recognized the need for maintaining low-viscosity epoxy solutions against stone in order to get good penetration and avoid leaving resin concentrated on the surface. Initially, static procedures were employed that held liquid against the surface, but these gave way to more dynamic approaches that wasted less material and were more convenient to install. Early work in Poland and Czechoslovakia went through this pattern with bisphenol A-derived epoxies, and more recently, Italian stone conservators have repeated the cycle with aliphatic resins. In the United States, the one figure in this field, Gauri, has encountered the same problems in a set of quite different opportunities and has developed methodologies and specifications suitable to his requirements. The efforts of these workers have resulted in the successful use of epoxy resins for a wide variety of stone structures and have made available strategies and procedures to preservationists who have a need for a consolidation that provides mechanical strengthening and long-term durability.

## Work in Poland

The earliest successful consolidation of artifacts with epoxy resins was carried out in the late 1960s by Domaslawski and his students. Domaslawski was concerned with achieving deep penetration without destroying water vapor permeability. He was able to get resin deep into the stone in his initial projects by using a cumbersome network of disposable pockets to maintain the contact of consolidating solutions with stone surfaces. This technique was later abandoned in favor of procedures where solutions were made to flow in a laminar manner against the stone for extended periods of time. Both methods provided penetrations of 5 to 10 cm into weathered limestone and sandstone.

One of the first of several projects using the pocket method (Chapter 9, "Application Procedures") was the 1966 restoration of the portal of the Eskens House in Torun, Poland. The portal was ornately sculpted gray sandstone that had been painted. Flaking was discernible under the paint layers, and extensive fragmentation and powdering had occurred where the paint had come off. The first step of the treatment was preconsolidation with a limited application of a 15% solution of Epidian-5 epoxy resin and hardener in a 1:5 blend of toluene and methanol. This penetrated to a depth of a few millimeters and stabilized the surface so that the paint layer could be taken off with an alkaline poultice paste mixture. Washing with water until the solution was neutral removed both the paste and salts contained in the stone and restored the

original porosity. The door frame, pilaster, capitals, bases, and socles were all treated using the pocket method. After the pockets were removed, the portal was wrapped in undisclosed plastic film for 10 days. This was not sufficient time for curing to be completed under the ambient conditions of 16-17 °C, and back migration caused darkening in some areas.

The Romanesque portal of the St. Mary Magdalene Church in Wroclaw is part of one of the most venerated historic monuments in Poland. In 1966 deterioration was so extensive that it was proposed that the portal be replaced by a copy and the original placed in a museum. Water and salts, which flowed into the portal from the interior side, were the primary cause of the decay. To prepare for the restoration, clinker bricks were removed from the immediate area of the doorway, the work area was enclosed to protect it from inclement weather, a cellar was created underneath to prevent the inflow of ground water, and the fragmented surface was temporarily secured by gluing paper over it. In order to get the portal to a point where deep consolidation could be undertaken, it was necessary to preconsolidate sections where exfoliation and erosion were occurring. This was done by coating the areas with a 20% epoxy solution, removing old gypsum putty and mortar from previous restorations, and then remortaring loose sections. Available porosity was partially restored by using poultices to desalinate the stone, scraping off old consolidants, and by washing with dilute aqueous hydrofluoric acid to remove environmentally caused contamination. Deep placement of the consolidating epoxy resin was achieved by the previously described cup method. Lost structural detail was repaired with a patching mortar made of epoxy resin and ground sandstone. Eleven years later state inspectors found that the stone was strong and showed no powdering, exfoliation, or peeling (Domaslowski and Strzelczyk 1986). The epoxy mortar was also in good condition. The report noted extensive darkening due to environmental pollution and some salt efflorescence. To respond to these findings, additional, localized desalination and consolidation was done and the portal was washed. Examination ten years later found the portal in a very good state of preservation.

Because of many difficulties in applying the pocket method, Domaslowski switched to a procedure where wicking was wrapped against the object to maintain a constant flow of resin solution against the stone. This method, which is described in Chapter 9, p. 73-76, was employed on a number of projects after the Wroclaw work. The best known are a Renaissance portal of a house in the Old Market in Torun (which was restored in 1969) and a sandstone statue of St. Francis in Klodzke. The portal, constructed of Gotland sandstone, had been badly damaged and eroded by natural weathering. It was treated with 80 liters of a 15% solution of epoxy resin in a mixture of toluene and methanol. After 17 years, both the consolidated stone and the structural repairs made using the epoxy mortars were in good condition and showed no deterioration (Domaslowski and Strzelczyk 1986, Wheeler 1990).

## Work in the United States

Restoration of stone with epoxy resins in the United States has been done almost exclusively by Gauri. His procedures have evolved from an extensive program of research and development at the University of Louisville on the destructive interaction of acidic pollutants, particularly sulfur dioxide, with marble and limestone, and the prevention and repair of damage with conventional epoxy resins. His studies have led to procedures most suitable for the consolidation of large surface areas, and from the early 1970s Gauri has directed the consolidation phase of a number of building restorations. One of the first projects undertaken did not go well—the U. S. Bank building in Philadelphia. The structure was clad in marble that had developed a hard gypsum crust on surfaces that were protected from the rain. The resin interacted with the gypsum and did not penetrate the stone. In areas where the gypsum had washed away, good consolidation was achieved. However, in 1991, his other projects were generally standing up well and showing little or no further deterioration. This includes structures as diverse as the First Baptist Church in Portland, Oregon and the Humana Conference and Fitness Center in Louisville. The sandstone church was built in 1894 and treated in 1978 with Epi-Rez 510. Almost a century after it was built, the restored church was in good shape. The Humana Center, a much newer structure, was clad in Indiana limestone. This was treated in 1983 and six years later was pronounced in excellent condition. Gauri's approach is characterized by the application of solutions based on acetone by spraying, the removal of discoloration by abrasion, a focus on the treatment of buildings rather than smaller artifacts, and the use of specifications to insure performance. This is seen in the more detailed descriptions of the three major projects that follow.

### The California Building, San Diego

One of the earliest and most notable of Gauri's efforts was the repair and restoration of the California Building in Balboa Park in San Diego, California. This was built in 1915 by the State of California as the only permanent building in an exposition celebrating the opening of the Panama Canal. The structure was described in a nomination inventory for the National Register of Historic Places as a magnificent example of Spanish baroque reproduction, one of the most outstanding examples of this style in North America (Fig. 17).

The California Building consists of a central dome flanked by four vaults and a bell tower. The exterior is constructed of cast stone made from fine quartzose granules, coarse sand, and a lime cement. This composition gives it the weathering characteristics of a highly porous sandstone with a calcitic binder. There is extensive ornamentation and statuary of this same cast stone around the main entrance of the building and on the upper stories of the tower. It was in these areas and on the plain, stuccoed facade of the seven lower levels of the tower where chemical consolidation was ultimately carried out. In the mid-1960s, concern about cracks in the tower led to some interim repairs. But in the following decade accelerating deterioration

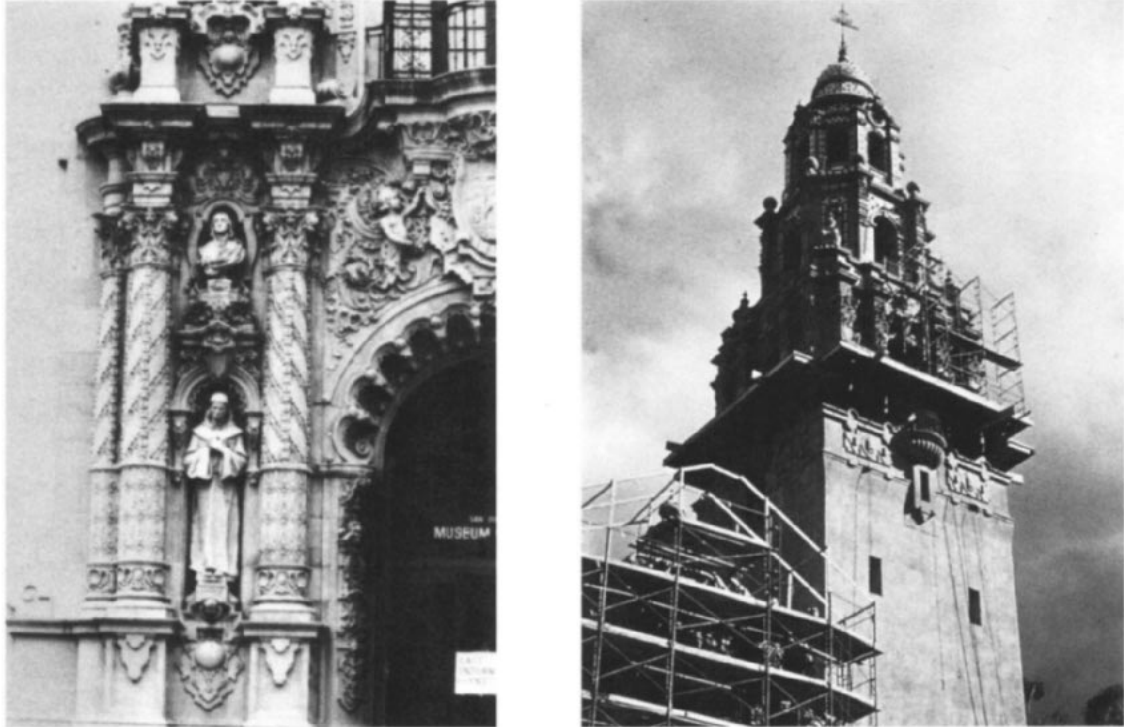

Figure 17, left. Spanish baroque reproductions on the California Building. 1969. (Courtesy of K. L. Gauri).  
Figure 18, right. Scaffolding on the tower. 1975. (Courtesy of K. L. Gauri)

was seen in the disappearance of detail, in the wearing away of ornamentation, and in the seepage of water and salts into the interior, seriously reducing its mechanical strength. Parts of the ornamentation cracked, came loose, disintegrated, or fell away. In some areas, pieces of stone could be pulled off by hand. In 1975, it was recognized that \$630,000 necessary to strengthen and remortar 85,000 ft<sup>2</sup> of precast stone relief would be much less than the cost of replacing the complex (Maydeck 1975). Figures 18 and 19 show the scaffolding used to carry out the treatment and provide a sense of the magnitude of the intervention.

Further analytical diagnosis showed that loss of detail in the ornamentation was due to dissolution of the calcitic cement and separation of unbonded sand grains. The white incrustation on the interior walls was analyzed by X-ray diffraction and found to be a complex mixture of calcium, sodium sulfates, and chlorides. Some of these components were present in the stone originally. They were joined by salts deposited from ocean spray or formed by the attack of pollutants on the calcareous cement. The cast stone ornamentation is attached to structural concrete reinforced with iron bars that rusted and expanded. This caused sections of both the stone and the concrete to rupture. To respond to this array of problems, a treatment had to be designed that would improve abrasion resistance and mechanical strength and decrease water absorption.





*Figure 19. Scaffold for the restoration of the California Building. 1975. (Courtesy of K. L. Gauri).*

Efflorescence was considered to be the major cause of stone decay in this building, and lowering the salt content, which was as high as 1.0% in some portions of the stone, to a safer level was a major undertaking. In areas where the stone showed no deterioration, the amount of sodium ions was about 0.02%, and this was selected as the specification for an acceptable level of total salt. After the surfaces were brushed free of encrustation, they were sprayed with water. A combination of water and rounded silica sand was applied by spraying where desalination to specification was easily achieved. In more stubborn areas, the surface was repeatedly treated with high-pressure steam followed immediately by cold water. As a final step, acetone was dripped down the surface to remove the water.

Laboratory studies demonstrated that once the salts were removed, impregnation of the weathered stone with a conventional epoxy resin combination left it with the desired properties. It was found that cores immersed first in 15% and then 25% solutions of bisphenol A diglycidyl ether and diethylenetriamine in acetone had their compressive strength, on average, increased from 220 to 400 psi. It was shown that application of the solutions by brushing provided penetration to 2.5 cm or more. These experiments resulted in a specification for the contractor that "the cast stone shall be impregnated to an average depth of one inch and the compressive strength of the treated stone shall be increased at least 50% over untreated cast stone." In the treatment of the California Building, these specifications were satisfied by spraying stepwise with 10 and 20%



*Figure 20. The California Building soon after restoration was completed. 1982. (Courtesy of K. L. Gauri).*

solutions of epoxy resin in acetone. Discoloration of treated areas by polymer was avoided by removing resin left on the surface. Gauri (1978) mentions the use of abrasion, but Szabo (1982) describes washing the stone with acetone.

The consolidation had little effect on the ability of water vapor to pass through the stone, and maintenance of at least 90% permeability was also set as a specification. Weathered stone showed much more capacity to absorb liquid water than fresh stone, and it was a major purpose of the consolidation to reduce the quantity of water that could be taken up. Treatment with the epoxy resin lowered water absorption from 12 to 1-2% and resulted in a specification that water absorption after consolidation should be less than 5% after 48 hours. As a final step, the surfaces were conditioned with a solution of a perfluoropolyether, Du Pont's Fluo-

ropolymer B in cellosolve acetate and methyl ethyl ketone. This gave a very stable coating that is a barrier to attack by sulfur dioxide and further increases water repellency. Today, the California Building is a living structure. It houses a well-attended anthropological museum (Fig. 20). The result of all the interventions provided an historic building generally recognized to be in good condition. After 15 years, the ornamentation is crisp and the stone is stable.

### **The Crescent Hill Baptist Church, Louisville**

A very similar program of treatment was used on the Crescent Hill Baptist Church in Louisville, Kentucky in 1983. This, too, was constructed of cast stone and had areas of deterioration and severe fracturing at the cornices, around the pediments and attached sculpture, through the walls supporting the steps to the main entrance, and through the parapet walls, balustrades, and various parts of the tower. Water, which completely saturated the stone in exposed areas, was the primary cause of these problems. The combined action of freeze-thaw cycles, salt efflorescence and the expansion of rusting reinforcement bars led to fractures appearing at the mortar joints and propagating through the stone. Extensive analyses were made on samples to determine water absorption, porosity, and salt content. The absorption ranged from 8 to 17%, while sulfate was found to be as high as 1.3% of the weight of the stone. After loose mortar was removed from the joints, the surfaces were brushed to remove salt and dirt. Desalination with steam, water, and acetone was used to get the stone to a dry condition with less than 0.1% sulfate. After repointing with lime mortar and patching with the mortar mixed with fine sand and crushed marble, cracks were filled with commercial epoxy formulations designed for pressure injection. Consolidation was achieved by spraying the surfaces with 12% epoxy resin (Epi-Rez 510 and Epi-Cure 876) in acetone for 30 minutes, followed by application of an 18% solution for 15 minutes. Laboratory tests showed this provided 2.5 cm of penetration and reduced the water absorption to less than half.

### **The Cathedral of the Assumption, Louisville**

Gauri's experience with epoxy resins was put to use most recently (1990-91) in developing a program for the preservation of the Cathedral of the Assumption in Louisville. This included an assessment of the causes of deterioration, measurement of the properties and characteristics of the stonelike components of the structure (brick, mortar, cast stone, Louisville limestone, and Indiana limestone), evaluating and selecting consolidants, cleaning and desalination, treatment and, lastly, intermediate term evaluation of the results.

The most damaging cause of deterioration was water penetration. In some areas where brick walls contained a methyl silicone to a depth of 0.5 cm, water soaked through in about one hour. In areas without the silicone, penetration occurred in 6 to 15 minutes. Overall, water tended to pass through mortar in 10 minutes and brick in 20 to 25 minutes, so that rainfall

of 35 minutes duration or longer resulted in water getting inside the single brick layer and wetting the interior of the Cathedral. Separation of interior stucco and peeling of paint layers was caused by gypsum and magnesium sulfate transported from the lime mortar by penetrating rain. Other parts of the structure in need of intervention were the crenulations made of argillaceous Louisville limestone and the oolitic Indiana limestone veneer on the foundation walls. The Louisville stone suffered cracking and substantial loss of surface by exfoliation, while the much harder Indiana limestone was well preserved except for surface roughness caused by grain dissociation. Insufficient mechanical strength, both in the original stone and by deterioration, was an attendant problem. While standards for exposed brick, grade SW, in the Louisville area require a compressive strength of 2500-3000 psi, the average compressive strength of the bricks in the Cathedral walls was only 2250 psi. Comparable results in water absorption and saturation coefficient measurements indicated that the original brick was only marginally acceptable for outdoor exposure. In addition, the mortar between the bricks was very porous and powdery and in need of strengthening.

The selection of chemicals for study in the evaluation phase was limited to an epoxy resin and a combination of commercial alkoxysilanes. Results of treatment with the epoxy resin, Epi-Rez 510 and Epi-Cure 856, 10% in acetone, and the alkoxysilanes, ethyl silicate and methyltriethoxysilane, which were each absorbed into the brick to a depth of 3-4 cm, were compared. Gauri recommended the epoxy resin for work on the Cathedral because it provided better bonding between mortar grains and mortar to brick than the silane derivatives. Also, Gauri claimed that the silane formed a higher concentration on the outer 0.3 cm layer of the brick, which made it nonpermeable and thus the water could be trapped within the stone. Laboratory evaluation studies showed that after treatment the brick, which was impregnated to a depth of about 4 cm, was able to resist water penetration for three hours. The quality of the wall strengthening depended on the contact of the old mortar with the brick. Generally this mortar became consolidated in a patchy manner. Good resin penetration into cast stone and Indiana limestone improved both the strength and the water repellency of these materials. The solution applied to the Louisville limestone carried primarily into the cracks and gave only minor impregnation of the sound stone. However, the stone no longer exfoliated. The procedures used on the church were based on these findings.

Before the church was treated, the stone was cleaned and desalinated by spraying with water, first at 82 °C under pressure, and then at ambient temperature for no longer than 5 minutes. After an acetone rinse, the masonry was allowed to dry for at least a day before consolidation was carried out. A 5:3 ratio by volume of Epi-Rez 510 to Epi-Cure 826 was dissolved in acetone to make 5, 10, and 15% solutions. Brick and mortar were sprayed with a single application of 10% solution over 20 minutes and the Indiana limestone was similarly treated with the 5% solution. More complicated schedules were employed on the more porous stones. Cast stone

was sprayed first with the 10% solution and then with the 20% concentration. Treatment for the Louisville limestone consisted of spraying with the 5% solution for 10 minutes followed by 10 and 20% solutions for 5 minutes each. This stone was cracked and the impregnant tended to leak out of the fractures. When streaks of liquid polymer appeared, it was necessary to immediately clean the surface thoroughly with acetone. Large cracks and cavities were patched and missing or badly decayed ornamentation was replaced by fiberglass-backed replicas. The patches and replicas were made from a mixture of fused quartz and natural sand of a grain size and color comparable to the original cast stone, and the Du Pont fluoropolymer and an acrylic polymer in solution. It was easier to produce replicas from a quartz, sand, and epoxy resin blend, but the products were discolored. Specifications established for the patching material after it had set are listed in Table 23.

| Property                                       | ASTM Method | Value  |
|--|-------------|--|
| Compressive strength                           | C 170-50    | > 200 kg/cm <sup>2</sup>                           |
| Modules of rupture                             | C 99-52     | > 50 kg/cm <sup>2</sup>                            |
| Water absorption                               | C 97-47     | < 4%   |
| Permeability                                   | C 577-68    | ± 5 centidarcy                                     |
| Color retention                                | G 27-70     | After 1000 hours there was no change in color      |
| Coefficient of thermal expansion               | E 228       | < 2.2 × 10 <sup>-6</sup> /C°                       |
| Burning characteristics                        | E 162-67    | 4-10 (flame index)                                 |
| Bond strength of composite to the parent stone | –           | Greater than the tensile strength of the composite |

Table 25. Properties of the compound for patching and replication (Gauri 1990).

## Work in Italy

After a period of laboratory evaluation (Chapter 7, "Aliphatic Epoxy Resins"), the cycloaliphatic epoxy resin, EP 2101, produced by STAC of Milan, Italy was applied to the preservation of a number of important stone monuments in several Italian cities. The work was done by the Restoration Working Society of Cartura following procedures developed by Marinelli and Lazzarini (Chapter 9, p. 75). For stone impregnation, EP 2101, available commercially as a 25% solution in toluene and isopropanol, is mixed with aliphatic polyamines to provide a consolidating system



Figure 21. *Gatta di Santa Andrea* (Lazzarini 1991).

Figure 22. Containment around a granite column (Lazzarini 1991).

consisting of 5 parts of resin, 1 part of hardener, 7.5 parts of toluene and 7.5 parts of isopropanol. The components are blended at room temperature, and an induction period of 2 to 8 hours is recommended before the mixture is used. In projects done before 1985 the formulation was applied by brushing. The first field project was done in 1983 on sections of a Roman aqueduct made of Viterbo tuff. Severe flaking and powdering of the stone were symptomatic of extensive deterioration. Treatment with the consolidating solution stabilized the tuff and arrested the process of decay. The stone initially displayed a change in color but with time, the oxidative deterioration of the exposed epoxy resin removed most of the discoloration, and the stone remained strong and stable.

The direct brushing procedure was used on several projects in the following year. These included panels of Chiampo limestone in a bell tower in Arzignano, four limestone window frames in the bell tower of the Chiesa Arcipretale della Nativita della Beata Vergine in Trent, and the Gatta di Santa Andrea also known as the *Venetian Lion*, a statue made of Euganean trachyte, a light-colored volcanic rock. The lion, standing atop a pink column, was made by Daniel Magister in 1207 to commemorate a Paduan military victory. Before treatment, the trachyte was scaling and powdering badly. Figure 21 shows the lion nine years after it was consolidated. The trachyte was not powdering, and fragments were firmly attached to the surface. For



Figure 23. Twin bases of the Basilica of San Andrea treated with resin (Lazzarini 1991).

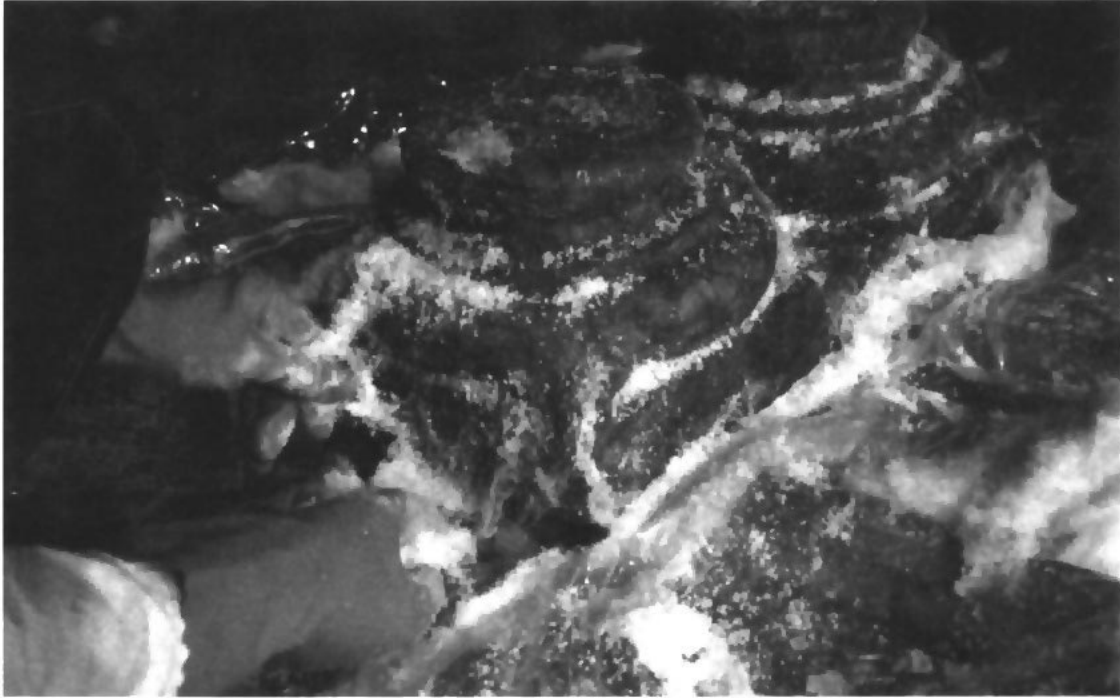

Figure 24. Removal of gelled resin solution after treatment of twin bases (Lazzarini 1991).

the Trent windows and the *Venetian Lion*, a cleaning of the stone surface by means of cotton swabs wetted in acetone and abrasion was required to remove the excess resin.

The chamber method devised in 1985 (Chapter 9, p. 75) has since been applied to a large number of objects both on site and in the laboratory. A granite column in the Murano section of Venice was restored in 1985. Containment was accomplished with a polyethylene tube and the air was displaced using a tap placed at the bottom of the tube. Figure 22 shows how this was arranged. The plastic sheath was firmly sealed at the bottom with a metal strap. The tap enabled solution to enter and displace air as it flowed upward. Plastic tape was wrapped around the outside to provide support. Inspection in April, 1991 found the surface to be in a sound state without appreciable surface discoloration. Also, in 1985 a green, oolitic limestone panel at the Church of San Zeno in Verona was restored on site. In this case, the envelope was constructed of plywood. In both cases, after the wadding was removed, only a simple brushing by hand was required to remove the residual consolidant from the stone surfaces.

A deteriorated base of a statue in the Church of Santa Maria Maggiore in Trent and the twin columns of the Basilica of Santa Andrea were restored in the laboratories of the Restoration Working Society. Each piece was wrapped in a waterproof sheet and then immersed in water to the top of the stone. The space between the artifact and the envelope was filled with resin. Impregnation was aided by the pressure of the head of water against the surfaces. When





*Figure 25. Twin columns of the Basilica of Santa Andrea in plastic containment in wood boxes (Lazzarini 1991).*

the resin had achieved a gelatin-like consistency, the pieces were removed and the surplus consolidant was wiped from the surface to leave well-consolidated products. For restoration of the twin columns of the Basilica of Santa Andrea in Montera, the columns and bases, were disassembled. Figure 23 shows the parts wrapped in plastic, the bases in the background and the columns in foreground. The boxes are plastic lined to hold the water. Figure 24 shows the twin bases wrapped in plastic to contain the epoxy solution while Figure 25 illustrates the removal of the gel left by the excess resin solution.

The Polish portals, the California Building, and sections of the Aqueduct near Rome are all examples that the treatment of deteriorating historic stone can be done successfully with epoxy resins. The placement of polymer in stone to stabilize and preserve it is an evolving area of material science. The stone conservators who designed and executed these projects have provided their colleagues with important tools in a limited armament of materials. They have solved many of the problems associated with the use of epoxy resins and this should encourage others to take advantage of this very useful stone consolidant.

# Appendix

## U. S. Suppliers

In the United States, several chemical companies manufacture and supply a range of epoxy resins based on bisphenol A. Generally they offer the same products. A list of trade names of comparable resins is shown in Table 24. The smallest amount of resin that can be purchased from these companies or their regional sales offices is a 55-gallon barrel although 5-gallon quantities can sometimes be purchased under special arrangement. We contacted a small number of independent distributors and found that most had the same policy but there were three exceptions that would sell any of their products in quantities as small as a pint. These companies, listed below, market throughout the United States. There may be other distributors supplying small quantities that could be found by a little inquiry. These companies and distributors also market the more widely used curing agents. Pacific Anchor Chemical has a very complete line of amine curing agents and will sell these in 55-pound quantities. Following is a list of the companies and the products they offer.

**Ciba-Geigy Chemical Corporation**

Plastics Division  
Seven Skyline Drive  
Hawthorne, NY 10532  
(914)347-6600

Araldite epoxy resins, hardeners

**Dow Chemical, USA**

Customer Service  
2040 Building  
Midland, MI 48674  
(1-800)232-2436

DER epoxy resins, hardeners

**Rhone Poulenc Chemical Company**

Performance Resins and Coatings Division  
9808 Bluegrass Parkway  
Louisville, KY 40299  
(502)499-4011

Epi-Rez epoxy resins, Epi-Cure hardeners

**Reichhold Chemicals**

P.O. Box 13582  
Research Triangle Park, N.C. 27709  
(1-800)874-5403

Epotuf resins, hardeners

**Shell Chemical Company**

320 Southwest Freeway  
Suite 1230  
Houston, TX 77027  
(1-800)832-3766

Epon epoxy resins and curing agents, Epon resins

**Acme Distributors**

1501 Summit Avenue, Suite 3  
Plano, TX 75074  
(1-800)527-4557

Epon, Eponex resins, Amine curing agents sold in pint and larger quantities

**E. V. Roberts and Associates**

85 Steller Drive  
Culver City, CA 90232  
(1-800)252-0199: California  
(1-800)421-0824: National

Epon, Eponex resins, Jeffamines and other amine curing agents sold in pint and larger quantities

**Tremecrete Corporation**

665 North County Road, #101  
Woodland, CA 95695  
(916)666-3633

Epi-Rez epoxy resins, Epi-Cure hardeners, Pacific Anchor, and Jeffamine hardeners sold in pint and larger quantities

**Pacific Anchor Chemical**

Performance Chemicals Division  
Air Products and Chemicals, Inc.  
7201 Hamilton Boulevard  
Allentown, PA 18195-1501  
(215)481-8935

Amine curing agents, minimum quantity is 55 pounds

## Suppliers Outside the United States

The five basic producers listed under U.S. Suppliers: Ciba-Geigy Chemical Corporation, Dow Chemical, Rhone Poulonc Chemical Company, Reichhold Chemicals, and Shell Chemical Company all have extensive sales networks around the world. The Ciba-Geigy Chemical Company, for example, has supply centers or technical sales offices in over eighty countries. Access to these companies and other major producers can be obtained, without difficulty, through telephone listings in larger cities. STAC sells its Eurostac 2101 epoxy components through a marketing company, Bresciani, S. r. l. Addresses for both organizations follow:

**STAC, S. r. l.**

Via S. Faustino, 64  
20134 Milano  
Italy  
26.411.971  
26.40.431  
21.42.258

**Bresciani, S. r. l.**

Via Padre Semeria, 8  
20128 Milano  
Italy  
(02)25.73.593

| Description of resin   | Supplier |               |            |     |           |
|--|----------|---------------|------------|-----|-----------|
|  | Shell    | Rhone Poulenc | Ciba-Geigy | Dow | Reichhold |
|  | Epon     | Epi-Rez       | Araldite   | DER | Epotuf    |
| Pure diglycidyl ether of bisphenol A (n = 0, pg 15)                            | 825      |               |            | 332 |           |
| Purified diglycidyl ether of bisphenol A, somewhat lighter than standard resin | 826      | 509           | GY6008     | 330 | 37-139    |
| Standard liquid resin (n = 0.14)   | 828      | 510           | GY6010     | 331 | 37-140    |
| Bisphenol resin diluted with cresyl glycidyl ether                             | 813      | 5077          | GY507      |     | 37-137    |
| Bisphenol resin diluted butyl glycidyl ether                                   | 815      | 5071          | GY506      |     | 37-130    |

Table 24. Trade names for commercial bisphenol A diglycidyl ether epoxy resins.

# References

## **Adhesive Engineering Company**

1980 Historic structures, construction, adhesives, coatings, sealants. Special edition. San Carlos, CA.

## **Alessandrini, G., R. Peruzzi, G. Giambelli, and M. Bassi**

1978 Conservation treatment on stone. *The International Symposium on the Deterioration and Protection of Stone Monuments, Paris*. RILEM. 7.1.

## **Alien, N. S., J. P. Binkley, B. J. Parsons, G. O. Phillips, and N. M. Tennent**

1982 Spectroscopic properties and photosensitivity of epoxy resins. *Polymer Photochemistry* 2:97-107.

## **Amoroso, G. G., and V. Fassina**

1983 Stone Decay and Conservation. *Materials Science Monographs II*. New York: Elsevier.

## **Aspect**

1983 Engineered to last another 1000 years. Ciba-Geigy. 27-29.

## **Bauer, R. S.**

1982 Formulating weatherable epoxy resin for maximum performance. (Paper presented at the Water Borne and Higher Solids Coatings Symposium, New Orleans). *Shell Chemical Company Technical Bulletin* SC: 729-83.

## **Blankenhorn, P. R., and D. E. Kline**

1977 Enhancement of compressive properties of failed concrete cylinders with polymer impregnation. *Journal of Testing and Evaluation* 5(4): 333-337.

## **Cavaletti, R., L. Lazzarini, L. Marchesini, and G. Marinelli**

1985 A new type of epoxy resin for the structural consolidation of badly decayed stones. *Fifth International Congress on the Deterioration and Conservation of Stone, Lausanne, Sept. 25-27*. 769-777.

## **Clifton, J.**

1984 Laboratory evaluation of stone consolidants. *Adhesives and Consolidants*. Paris. 151-155.

**Corrosion Prevention and Control**

1974 Epoxy resins save Venice church. 12-13.

**Crosby, A.**

1980 Conservation of painted lime plaster on mudbrick walls at Tumacacori National Monument, USA. *Third International Symposium on Mudbrick (Adobe) Preservation, Ankara*. 59-78.

**Cuttano, M., P. Mastronardi, and R. Rossi-Manaresi**

1981 Alveolar weathering of the "tuff" of Matera: mechanism of deterioration and effectiveness of preservation treatments. *The Conservation of Stone II, Preprints of the Contributions to the International Symposium, Bologna, October 27-30*. 355-377.

**Davison, S.**

1978 The problems of restoring glass vessels. *The Conservator* 2:3-8.

**De Witte, E., A. E. Charola, and R. P. Sherryl**

1985 Preliminary tests on commercial stone consolidants. *Fifth International Congress on Deterioration and Conservation of Stone, Lausanne, Sept. 25-27*. 709-718.

**Domaslowski, W.**

1967 Conservation/consolidation of stone with solutions of epoxy resins with the sample of the portal of the Eskens House in Torun (in Polish). *Biblioteka Muzealnictwa, i Ochrony Zabytkow* 19:91-109.

1969 Consolidation of stone objects with epoxy resins. *Monumentum* 4:51-64.

1970 The conservation of the stone portal from Olbin in the Saint Magdalene Church in Wroclaw (in Polish). *Ochrona Zabytkow* 23:11-27.

**Domaslowski, W. and A. Strzelczyk**

1986 Evaluation of applicability of epoxy resins to conservation of stone historic monuments. Case Studies in the Conservation of Stone and Wall Painting. *Preprints of the Contributions to the Bologna Congress*. 126-132.

**Down, J.**

1984 The yellowing of epoxy resin adhesives: report on natural dark aging. *Studies in Conservation* 29:63-76.



1986 The yellowing of epoxy resin adhesives: report on high-intensity light aging. *Studies in Conservation* 31:159-170.

**Fiori, C., F. Donati, R. Mabelli, P. Racagni, and E. Roncari**

1987 Study of a lime-nucleus treated with three different types (acrylic, silicone, epoxy) of resins. *Conservation in Situ, Musaicos 4*. Soria.

**Fukuda, M., S. Miura, and T. Nishiura**

1984 The breaking of stone remains caused by freezing and protection by treatment with synthetic resins; Part II: Studies on the deterioration caused by freeze-thaw cycles and its prevention. *Sciencefor Conservation* 23:1-12.

**Fukuda, M., S. Miura, T. Nishiura, and T. Matsuoko**

1983 The breaking of stone remains caused by freezing and protection by the treatment with synthetic resins; Part I: Studies on the deterioration of stone caused by freeze-thaw cycles and its prevention. *Sciencefor Conservation* 22:1-14.

**Gauri, K. L.**

1970 Improved impregnation technique for the preservation of stone statuary. *Nature* 228:882.

1974 Efficiency of epoxy resins as stone preservatives. *Studies in Conservation* 19:100-101.

1978 Conservation of the California Building, San Diego, USA: A case history. *The International Symposium on the Deterioration and Protection of Stone Monuments, Paris*. RILEM. 7.5.

1990 Private communication.

**Gauri, K. L., G. Doderer, N. T. Lipscomb, and A. C. Sarma**

1973 Reactivity of treated and untreated marble specimens in an SO<sub>2</sub> atmosphere. *Studies in Conservation* 18:25-35.

**Gauri, K. L., and V. A. R. Madiraju**

1978 Certain epoxies, fluorocarbon-acrylics and silicones as stone preservatives. *Geological Society of America, Engineering Geology Case Histories II*:73-79.

**Henderson, M. E. K., and R. B. Duff**

1963 *Journal of Soil Science* 14:236-246.

**Hueck van der Plas, E. H.**

1968 *International Biodeterioration* 4 (1): 11-28.

**Koestler, R. J., A. E. Charola, M. T. Wypyski, and J. J. Lee**

1985 Microbiologically induced deterioration of dolomitic and calcitic stone as viewed by scanning electron microscopy. *Fifth International Congress on Deterioration and Conservation of Stone, Lausanne, Sept. 25-27.* 617-626.

**Koestler, R. J., E. D. Santoro, J. Druzik, F. Preusser, L. Keopp, and M. Derrick**

1987 Status report: Ongoing studies of the susceptibility of stone consolidants to microbiologically induced deterioration. *Biodeterioration* 7. Cambridge, England.

**Koestler, R. J., E. D. Santoro, F. Preusser, and A. Rodarte**

1987 A note on the reaction of methyl trimethoxysilane to mixed cultures of microorganisms. *Proceedings of the First Pan-American Biodeterioration Society Meeting, Washington, D. C., July 17-19, 1986.* C. O'Rear and G. C. Llewellyn, eds. New York:Plenum Press. 317-322.

**Koestler, R. J., E. D. Santoro, L. Ransick, R. H. Brill, and M. Lynn**

1987 Preliminary scanning electron microscopy study of microbiologically induced deterioration of high alkali low-lime glass. *Proceedings of the First Pan-American Biodeterioration Society Meeting, Washington, D. C., July 17-19, 1986.* C. O'Rear and G. C. Llewellyn, eds. New York:Plenum Press. 295-308.

**Kotlik, P.**

1990 Private communication.

**Kotlik, P., P. Justd, and J. Zelinger**

1983 The application of epoxy resins for the consolidation of porous stone. *Studies in Conservation* 28:75-79.

**Kotlik, P., I. Pickoud, and J. Zelinger**

1981 Sitovani epoxidevych pryskyvic v pritomnosti rouponsdel (The cross-linking of epoxy resins in the presence of solvent.) *Sbornik Vysoké Skoly Chemicko-Technologické v Praze, Polymery-Chemie, Vlastuosti, a Zpracovani, Kousevace a Res-taurovani Kulturnich Pamatek* S6:87-169.

**Kotlik, P., and J. Zelinger**

- 1983 Physical properties of sandstone on impregnation with organosilicon consolidants and epoxy resin. *Sbornik Vysoké Skoly Chemicko-Technologické v Praze* S10:129-142.

**Laukhuf, W., C. A. Plank, and K. L. Gauri**

- 1982 Mechanisms of SO<sub>2</sub> adsorption in epoxy resins. *Fourth International Congress on the Deterioration and Preservation of Stone Objects, Louisville, Kentucky*. 239-241.

**Lazzarini, L.**

- 1990 Private communication.

**Marinelli, G.**

- 1975 Use of an epoxy aliphatic resin in the consolidation of porous building materials having poor mechanical properties. *Proceedings of the Meeting of the Joint Committee for the Conservation of Stone, Bologna*. 573-591.

**May, C. A.**

- 1985 *Epoxy Resins, Chemistry and Technology*. 2nd ed. New York: Marcel Dekker.

**Maydeck, R.**

- 1975 Space age discoveries renew park buildings. *San Diego Evening Tribune*, August 8.

**Mirowski, R.**

- 1988 A new method of impregnation of stone historical objects. *Sixth International Congress on Deterioration and Conservation of Stone, Torun*. 633-640.

**Moncrieff, A., and K. Hempel**

- 1970 Work on the degeneration of sculptural stone. *New York Conference of Stone and Wooden Objects*. 103-114.
- 1977 Conservation of sculptural stonework: Virgin and Child on S. Maria dei Miracoli and the Loggetta of the Campanile, Venice. *Studies in Conservation* 22:1-11.

**Munnikendam, R. A.**

- 1971 The combination of low-viscosity resins and silicon esters for the consolidation of stone. *Proceedings of the Meeting of the Joint Committee for the Conservation of*

*Stone, Bologna.* 197-200.

- 1973 A new system for the consolidation of fragile stone. *Studies in Conservation* 18:95-97.

**Nishiura, T., F. Masami, and S. Miura**

- 1984 Treatment of stone with synthetic resins for its protection against damage by freeze-thaw cycles. *Adhesives and Consolidants.* 156-159.

**Pankhurst, E. S., M. J. Davies, and H. M. Blake**

- 1972 The ability of polymers or materials containing polymers to provide a source of carbon for selected microorganisms. *Biodeterioration of Materials* 2:76-90.

**Phillips, M. W., and J. E. Selwyn**

- 1978 *Epoxies for wood repair in historic buildings.* U. S. Department of the Interior, Washington, D. C.

**Proudfoot, T., K. Garland, and J. Larsen**

- 1988 The examination and conservation of a collection of Gandharan sculptures from Antony House, Cornwall. *The Conservation of Far Eastern Art, IIC, Kyoto Conference.* 113-120.

**Riederer, J.**

- 1981 The preservation of historical monuments in Sri Lanka. *The Conservation of Stone II. Preprints of the Contributions to the International Symposium, Bologna.* 737-759.

**Rossi-Manaresi, R.**

- 1981 Effectiveness of conservation treatments for the sandstone of monuments in Bologna. *The Conservation of Stone II. Preprints of the Contributions to the International Symposium, Bologna.* 665-688.
- 1975 Treatment for stone consolidation. *Proceedings of the Meeting of the Joint Committee for the Conservation of Stone, Bologna.* 547-569.

**Rossi-Manaresi, R., and C. Ghezzi**

- 1978 The biocalcarene of the Agrigento Greek temples: causes of the alteration and effectiveness of conservation treatments. *The International Symposium on the Deterioration and Protection of Stone Monuments, Paris.* RILEM. 7.9.

**Schweinsberg, D. P., and G. A. George**

1986 A chemiluminescence study of the properties and degradation of epoxy resins as coatings. *Corrosion Science* 26(5): 331-340.

**Shaw, S. J., D. A. Tod, and J. R. Griffith**

1988 The mechanical and water absorption behavior of fluoroepoxy resins. *Polymer Science and Technology* 37:45-66.

**Shechter, L, J. Wynstra, and Kuvkij**

1956 Glycidyl ether reactions with amines. *Industrial and Engineering Chemistry* 48:94-97.

**Sleater, G. A.**

1977 Methods of laboratory testing and preliminary performance criteria. *National Bureau of Standards, Technical Notes 941*. Washington, D. C.

**Stone Industry**

1984 Resins for repair. 19(2): 24-25.

**Szabo, E. F., and G. T. Szabo Jr.**

1982 Cleaning and Restoration of the California Building, Balboa Park, San Diego, California. *Fourth International Congress on the Deterioration and Preservation of Stone Objects, Louisville, Kentucky*. 321-333.

**Tennent, N. H.**

1979 Clear and pigmented epoxy resins for stained glass conservation: light aging studies. *Studies in Conservation* 24:153-164.

**Tobasso, M., P. Laurenzi, and R. Rossi-Doria**

1974 Proposte per un metodo di controllo dei trattamenti da effettuate su opere d'arte in pietra. *L'Ingegnere* 4.

**Ullrich, C. R.**

1971 Some geo-ecological effects of air pollutants. Master of Science Thesis, University of Louisville.

**Wakeman, C. M., H. E. Spencer, and E. N. Bly**

1962 Glue for concrete repair. *Materials Research and Standards* 2:93-97.

**Webley, D. M., M. E. K. Henderson, and J. F. Taylor**

1963 *Journal of Soil Science* 14:102-112.

**Wheeler, G.**

1989 Private communication.

1990 Private communication.

# Index

## A

Ablebond 342-1 29

abrasion, of stone

disadvantages of 8

as method to eliminate discoloration  
10, 31, 79, 82

resistance to 80

accelerators 9

acetone, epoxy resin solution in 10, 21-22, 24, 59,  
65, 66, 67, 68

application procedures for 21, 69, 84

acid rain, erosion by 41, 43

acrylic resins

evaluation of 35-36, 41-42

fluorinated, for protection of marble 41-42

and fungal deterioration 32

inadequacy as glass adhesive 28

and limestone 6

additives, for epoxy resins 8, 13

alcohols 10, 57, 65. *See also: hydroxyl  
compounds, solvents*

Alessandrini, G. 22

aliphatic epoxy resins 7, 16, 29, 39, 41, 49-55

application procedures for 76

and attack by sulfur dioxide 17, 41

as best resin for consolidating statuary  
76, 85-86

compared to bisphenol diglycidyl ethers  
52-54

low-viscosity 49

and resistance to discoloration 30, 49, 53-54

for stabilization of synthetic stone 55

aliphatic glycols, diglycidyl ethers of 16

alkoxysilanes

evaluation of 35-36, 84

for treatment of limestone 6

for treatment of porous tuffs 41

aluminum foils, as wrapping material  
24, 25, 41, 44

amidoamines 7, 19

with accelerators 9

as alternatives to polyamines 17

defined 17

Versamids, as class of 17

amidopolyamines, with aliphatic polyethers 29

amine carbonates

how to avoid formation of 18

amines 6, 7, 65

aromatic 17

as curing agents 18, 29

cycloaliphatic 17, 18, 21, 22, 49

ethers of 37

hindered 35

multifunctional aspects of 65

primary 13, 18

secondary 13, 18

tertiary 18

types of, compared 30

Aminoamid D 500 64-66, 68

aminopoly(ethyleneamine)s

characteristics of 17, 18, 29, 65

how to improve light stability of 29

aminopoly(oxypropylamine)s 18

animal gelatins 13

application procedures 1-3, 5-6, 8-9, 62, 69-76,  
77-89. *See also: names of individual types of applica-  
tion procedures*

for achieving colorfastness 31

for achieving deep penetration 21, 40, 62

by brushing 9, 21, 69, 76, 81, 87

bulk 73-75

by chamber method 75, 88-89

- by containment 6, 11, 12, 55, 75-76, 88-89  
 with flow techniques 77, 78  
 with heated resins 35, 37-38  
 of neat systems 1, 5  
 by pressure injection 83  
 by spraying 8, 9, 10, 11, 21, 69, 79, 81, 83, 84, 85  
 by standing liquids, for small contact areas 71  
 using pocket methods 9, 69-73, 77-78  
 with wrapping materials 24-25, 31, 38, 73, 74-75
- Araldites (Ciba-Geigy epoxy resins) 3, 7, 15, 49  
 aromatic compounds 7, 8, 10, 17, 65. *See also: names of individual types of aromatic compounds*  
 application procedures with 75  
 compared to aliphatic epoxies 17  
 relative viscosity of 16
- B**
- Bauer, R. 50-52  
 benzyldimethylamines 37  
 biocidal activity of phenolic groups 33  
 biodegradation, resistance to 32-33  
 bisphenol A 1, 8-9  
 building blocks of 14  
 commercial, comparison of 94  
     commercial, viscosities of 35  
 diglycidyl ethers of 7, 14-15, 18, 25, 27, 81  
 effects of solvents on, compared 57-68  
 hydrogenated, diglycidyl ethers of 37  
 in immersion solutions 25  
 penetration properties of 26  
 properties of 15, 30, 50  
 protection of marbles with 41-42  
 resistance of, to biodegradation 33
- in salt removal 37  
 stability of, with different hardeners 30  
 uses of 52
- Bologna Cocktail (B-72 and polysiloxane) 40  
 Bolognese sandstones, yellow 6, 35, 39, 50
- bonding  
 of glass 28-29  
 of stone and polymer 16
- bricks, treatment of 32, 84
- brushing, of stone surfaces 9, 21, 69, 76, 83  
 compared to flow procedures 27-28  
 with heated resins 37-38
- butadiene diepoxides 35
- butane diglycidyl ethers, in salt removal system 37
- butanediols, resins derived from 6, 16  
 diglycidyl ethers of 35, 39  
 low hydrophobicity of 17, 50
- butanol 57
- butyl acetates 66, 67, 68
- C**
- calcite  
 as binder of sandstone 35, 39, 80  
 in mosaics 53
- calcium sulfate, on treated marble 23
- capillary rise, of epoxy resin solutions  
 in different types of stone 23, 26, 62  
 as factor in treatability of stone 23  
 and porosity 24  
 and transport of epoxy resin solutions 24
- capillary structures, of stone 24
- cast stone. *See: synthetic stone*
- Cavaletti, R. 30
- cellophane film 72. *See also: application procedures, wrappings*



- cellulose  
 as poultice 71  
 as wadding 10, 75, 76
- chalking 31
- chamber method. *See: application procedures*
- chloroform 67
- chromatographic effects 24
- chromophoric structures, formation of 28
- Ciba-Geigy epoxy resins 49. *See also: Araldites*
- Clifton, J. 5, 41
- color formation 28-31, 67, 68. *See also: discoloration*
- color stability, of epoxy resins 28-31, 53, 68. *See also: names of individual types of resins*
- colors, of resins with different solvents 67, 68
- consolidants  
 low-viscosity 6, 35  
 for protection of marbles, compared 42  
 for severe delamination 37  
 silane-derived 24, 35, 37  
 solutions of, compared 5, 24, 36-37, 39-47, 57-59  
 tensile strengths of, compared 43
- consolidation. *See also: application procedures*  
 with concentrated solutions 26, 44  
 by containment method 6, 11, 12, 76  
 by different agents, compared 39-47  
 of different types of stone 5-6, 21-24, 52  
 of different types of substrates 24  
 factors affecting success of 21, 44  
 in field practice 77-90  
 of foliated stone 37  
 of limestone powder 36  
 of marble 21-23  
 and passage of water 3  
 and salt content 9  
 by solution recycling systems 10  
 of wood 30, 38f
- containment method. *See: application procedures*
- crust formation  
 caused by solvent evaporation 10  
 of epoxy resins 6, 31, 43  
 of hard gypsum 23
- cured resins  
 and hydrolysis 6  
 oxidative deterioration of 8
- curing, of epoxy resins 13, 19, 52, 57-68  
 agents of 27, 40, 52, 59  
 effects of water on 59, 62  
 rates of 17, 27, 57-63, 72
- Cuttano, M. 24, 26
- cyanoacrylates 13  
 inadequacy as glass adhesives 28
- cycloaliphatic epoxy resins 7, 9, 11, 75, 85  
 colorfastness of 30  
 compared with other consolidants 55  
 structures of 16, 50
- cyclohexanone 65, 66, 67, 68
- ## D
- darkening. *See also: discoloration*  
 causes of 24, 53, 78  
 of epoxy resins 40, 41  
 of stone surfaces 6, 10
- desalinization, of stone 11, 46, 73, 83
- DETA (diethylenetriamine), as hardener 7, 8, 25
- De Witte, E. 40
- diamines, types of 18
- diaminopoly(propylene oxide) 30
- dibutyl phosphates 37

- dibutyl phthalates 37
- diepoxides, high reactivity of 35
- diethylenetriamine 17, 19, 25, 81
- diglycidyl ethers, of bisphenol A 7, 14, 27  
rate of curing of 18
- dimer acids 7, 19. *See also: amidoamines*
- dioxane 59
- discoloration, of stone 17, 29, 31, 53, 75. *See also: names of individual types of discoloration*  
elimination of, by abrasion 10, 31, 79, 82  
by epoxy resins 6, 8, 28, 40, 49-50, 82  
by exposure to oxygen and sunlight 28  
by heated application 37, 38  
products resistant to 17, 18
- Domaslowski, W. 3, 8, 18, 23, 30, 32, 41, 59, 61  
procedures developed by 9-10, 73-74, 77-78
- Down, J. 29
- DriFilm 53, 104
- E**
- efflorescence, of stone 81, 83
- environmental corrosion, of treated stone 39, 44, 63, 64
- EP 2101 (STAC) 11, 30, 52-55, 85
- epichlorohydrins, with bisphenol A 14-15, 50
- Epi-Cure 9, 11, 84. *See also: bisphenol A*
- Epidians 64, 72, 75. *See also: Epons*
- Epi-Rez 9, 11, 79, 84. *See also: bisphenol A*
- Eponex (Shell Chemical) 7, 11, 16  
color stability of 30  
hardening rates of, compared 52  
improved outdoor performance of 50-51
- Epons (Shell Chemical) 7, 15
- Epo-Tek series 29, 30
- epoxides 8
- epoxy adducts  
as alternatives to polyamines 17  
aminopoly(ethyleneamine), defined 17
- epoxy resins. *See also: names of individual types of epoxy resins*  
additives with 8  
as adhesives 28-29, 35  
advantages of 1, 28-29, 53  
application procedures for 69-76  
color stability of 28-31  
commercial 9, 11, 14, 37, 94  
compared to other consolidants 1-3, 5-6, 39-47, 49-55  
concentrations of 24, 60-62  
crust formation of 6, 10, 31, 43  
cured 6, 8  
defined 1, 13  
development of 3, 10, 11  
disadvantages of 5-6, 28, 39, 43  
as glass adhesive 28-29  
light stability of 28, 51  
low-viscosity formulations of 35-37, 49  
nonsolvent systems of 35-37  
pot life of 57-58  
as protection against erosion by acid rain 43  
resistance to biodegradation 32-33  
solutions of 9, 12, 23, 35, 40  
solutions of, concentrated 25-26, 44, 54, 62-65  
suppliers 91-92  
treatability of different types of stone with 24  
types of 1, 7-9, 15-16, 49-55  
uses of 1-2, 3, 5, 10  
viscosities of 35-37, 57, 65-68
- esters 65

ethanols 65, 67, 68

ethyl silicate 6

and butane diglycidyl ether 37

for consolidation 37

for stabilizing limestone 41

evaporation, of solvents 17, 59

and crust formation 10

prevention of 24-25

exfoliation, of stone 39, 78, 84

## F

fatty acids 7, 17. *See also: amidoamines*

in changing light stability of polyamines 29

Fiedehungsmessgerete device 45

field results

in Europe 77-78, 85-90

in the United States 79-85

flow procedures

compared to brushing 27-28

fluorinated acrylic resins. *See: acrylic resins*

fluoroalkyl compounds

as deterrents to sulfur dioxide 17

Fluoropolymer B (perfluoropolyether) 82-83

forward (inward) migration, of resin molecule.  
*See: migration*

freeze-thaw deterioration, of stone 41

fungi, as agents of biodegradation 32-33

## G

Gauri, K.L. 3, 8, 16, 23, 41, 77

procedures developed by 10-11, 22, 31, 42,  
69, 79-85

glass

adhesives for 28-29

repair of 18

glycols, small four-carbon 6

grain boundaries

deterioration of 22

granite 52, 53

gypsum

crust, on marble 79

and sand, in application procedures 72

## H

hardeners 6, 7, 17-19

cause of discoloration 18, 29-30

Hempel, K. 6, 37, 38

humidity

and absorption of resin 16

hydrocarbons, aromatic 65

hydrochloric acid, resistance to 36

hydrogenation

of bisphenol A 15

hydrolysis 6

hydroxyl groups 57

secondary 13

## I

immersion, of stones

as consolidation treatment 24-26, 37

for removal of salts 46-47

impregnation

by concentrated resin solutions 25-26

patterns of, by brushing 27

inert diluents, types of 57

inward migration. *See: migration*

isophorone diamines 18, 19

isopropanol, as co-solvent 11, 21, 22, 85

formula for 87

**J**

Jeffamine series (Texaco) 8, 18, 19, 52. *See also:*  
*aminopoly(oxypropylamine)s*

**K**

K2101 53

Koestler, R. J. 32

Kotlik, P. 8, 10, 16, 24, 25-26, 44, 50, 57, 59, 64, 75  
procedures developed by 25-26

**L**

Lazzarini, L. 7, 55, 75-76

procedures developed by 10, 11, 85-89

limestone

and acid rain 43

biodegradation of 33

capillary rise in 23-24, 62

porosity of 62

treatments of 3, 6, 8, 10, 23-24, 41, 52-53, 59,  
62, 75, 77-78, 79, 84, 85, 87-88

types of 9, 10, 23, 41, 53, 54, 63, 64, 79, 84,  
85, 87

void spaces in 23

weathered vs. unweathered 22-23

limestone powder

added to consolidants 43

consolidation of 5, 36

**M**

Madiraju, V. A. R. 41

Marasettresins 6, 37, 38

marble

in humid environments 16-17

layers of 22

porosity factors of 9, 22-23

protection of, against attack by sulfur  
dioxide 41

treatments of 3, 8, 21-23, 37, 38, 52, 79

types of 22-23, 38, 53, 54

weathered vs. unweathered 22-23

Marinelli, G. 49

procedures developed by 52-53, 85-89

Marinelli formulation 53

menthane diamine 18, 19

methanols

compared to other solvents 65, 67

used as co-solvents 25, 26, 59-61, 64, 72

methyl ethyl ketone 40, 59

methyl isobutyl ketone 58

methyl methacrylate

polymers of 43

prepolymers of 1-2

methyltrimethoxysilane 7, 36, 37

in concentrated solutions 44

mica schists 36

microbial agents 32-33. *See also: biodegradation*

migration, of polymers 24-27, 78

forward (inward), defined 24-25

reverse, defined 24

Mirowski, R. 71

Moncrieff, A. 6, 37, 38

mortars

with brick, treatments of 1, 84

made with epoxy resins 73, 78

mosaics, consolidation of 53

Munnikendam, R. A. 6, 35

Munnikendam formulation 35, 37, 39-40

## N

Nishiura, T. 41

nonsolvent systems 35-38, 40

## O

oligomers 15, 24, 65

outdoor sites, treatment of 1, 3, 21, 36, 77-90

oxidative deterioration 8

oxiranes 13-14, 18

oxygen, exposure to

as contributor to discoloration 28

## P

Pankhurst, E. S. 32

Paraloid B-72 36, 40, 53

patching materials

compared 85

specifications for 63

penetration

by concentrated solutions, effectiveness of 44

by different consolidants 40-43

procedures for achieving 2, 8, 9, 10, 40

and rate of curing 17

of resin solutions 21-28, 43

and stone characteristics 9, 21-24

pentaerythritol, tetraglycidyl ethers of 21, 22, 39, 49-50

darkening of 40

percolation, as penetration method 40

perfluoropolyether 82-83

plasticization, of resins

by water absorption 16

pocket procedures, of application 9, 69-73, 77-78

poultice, alkaline paste of 77

polarity

of solvent and solute 24

of stone surface 9, 21

pollutants

effects of 36, 78, 79, 80

protection against 17, 43, 79, 83

polyamides, and curing of resins 57

polyamines

characteristics of 17

mixed with other compounds 7-8, 11

polyethylene films, as wrapping material 24, 31, 25, 38, 44, 73, 75

poly(ethylene oxide)s, as addends 29

poly(ethylene terephthalate)s, as wrapping material 38

polymerization, of bisphenol A diglycidyl ethers

catalytic 17

defined 13

effects of solvents on 60

rates of 9

polymers 2

deposition of 24

isocyanate-derived 13

migration of 24-27

organic, durability of 1, 3

precipitation of 68

precursors of 2

polymer-silanes 36

polypropylene ethers 8

polysiloxane 40, 53. *See also: Bologna Cocktail, DriFilm 104*

polyureas, and fungal deterioration 32

poly(vinyl acetate)s, and fungal deterioration 32

pore structures, of stone 21, 24, 25, 54

## porosity

of aliphatic films 16-17

of stone 9, 21-24, 62

pot life, of resins 57-58

## precipitation

consolidant films deposited by 17, 64

effects of different solvents on 59-61, 67, 68

rates of 18, 60-61

of resins 26, 67, 68

of solvents 59-61

pressure injection 83. *See also: application procedures*

Proconessian marbles 53, 54

Proudfoot, T. 6, 37

## R

rainwater, effects of exposure to 36, 38, 39.  
*See also: acid rain*

reverse migration 24. *See also: migration*

elimination of 24-25

Riederer, J. 32

Rossi-Manaresi, R. 6, 35, 39

## S

## salts

crystallization of 39, 49

deposited by ocean spray 80

as deterioration factor 35, 78

efflorescence of 78

formed by pollutants 80

removal of 37, 46-47

soluble content of, in stone 9, 11, 46

sandblasting, for color removal 49

## sandstone

application procedures for 69, 71, 73-74, 77-79

biodegradation of 33

capillary rise in 23-24, 26, 62

porosity of 9, 22-23, 62

synthetic cast 24

treated, compressive strengths of 45-47

treatments of 5, 9, 21, 23-25, 35, 59, 62, 77, 78, 79

types of 44, 46-47, 63, 64

separation, between solvent and solute 24

serpentinites 36

shellacs, and fungal deterioration 32

silanes 7

in concentrated solutions 44

concentrations of, on surfaces 84

derivatives of 32

with epoxy resins 37

esters of 6, 35, 39, 46, 47

penetrating power of 37, 43, 44

as reactive solvents for resins 36

Silane Z 6070 (Dow Corning) 7. *See also: methyl trimethoxysilane*

silica sand, as treatment material 81

Sleater, G. A. 44

sodium silicate 45

solution recycle systems 10

solventless epoxy resins. *See: nonsolvent systems*

solvents. *See also: names of individual types of solvents*

acetone 10

aprotic 57

composition of different 57

effects on resins, compared 57-68

importance of 40

polarity of 24

problems with 6  
 types of 3, 59, 66, 67, 68  
 viscosity of, compared 65-68  
 spalling, of stone 39  
 spraying. *See: application procedures*  
 statuary, treatments of 3, 10  
 steam, high-pressure  
   for removal of salts 11  
 stone. *See also: names of individual types of stone*  
   absorption characteristics of 21-24, 54  
   calcitic, protection for 17  
   chemical composition of 9  
   compressive strengths of, compared 54  
   consolidation of  
     by different agents, compared 39-42  
     weathered 2, 23-24  
   discoloration of, compared 54  
   mechanical strengthening of 39-42  
   porosity of 9, 23, 40, 54  
   repair of, with nonsolvent systems 35-37  
   salt content of 9  
   surface polarity of 9  
   treated, environmental corrosion of 44  
   types of 22-24, 52-54  
   weathered vs. unweathered 22-23, 82  
 Strzelczyk, A. 30, 32  
 sulfur dioxide. *See: pollutants*  
 sunlight, and discoloration 28  
 synthetic stone, cast 2, 9, 24  
   discoloration of 31  
   treatments of 21, 49-50, 52, 55, 69, 79-50, 83, 85  
   weathering characteristics of 79  
 Szabo, E. F. 82

## T

temperature  
   of environment, changes in 36  
   of resin treatments 35, 37-38  
 Tennent, N. H. 29  
 TETA (triethylenetetramine) 7, 8  
 tetraethyl silicate  
   effectiveness of 36, 44  
   used to lower viscosity 35  
 tetrahydrofurans 67, 68  
 toluene, as co-solvent 18, 24, 27, 59, 64, 65, 67, 72, 85  
   formula for 87  
 toxicity  
   of butanediol diglycidyl ethers, compared 35  
   of polyamines 17, 29  
   of solvents 65  
 trachyte 53, 54, 87  
 triethylenetetramine 17, 18, 19, 30, 59, 64, 72  
 triphenylphosphite 37  
 tris(dimethylaminomethyl)phenols 18, 19  
 tuff  
   freeze-thaw deterioration of 41  
   treatments of 9, 21, 24, 35  
   types of 21, 53, 54  
 2-methyl-4-ethylimidazol 18

## U

Ullrich, C. R. 22, 33f  
 ultraviolet radiation, exposure of resins to 51-52.  
*See also: sunlight*

**V**

vapor pressure, of polyandries 17

Versamids

compared with triethylenetetramine 18

defined 17

rates of precipitation of cured resin with 18.

*See also: amidoamines*

vinylcyclohexene dioxide 35

viscosity

of epoxy resins 5-6, 9, 15-16, 26, 35-36

of epoxy resins with solvents 57, 65-68

of solvents, compared 65-68

void spaces, in stone 22-23, 26

volatility

of aminopoly(ethyleneamine)s 29

volcanic rock, treatments of 53, 87

**W**

wadding, types of 10, 35, 73

water

absorption by resin of 16

absorption by stone of 11, 39-40, 69, 78, 82-83

effects on curing rates of resins 59, 62

repellency 9, 23, 68, 82-83

used as wash 72, 81

white bloom, as temporary discoloration

37, 38, 40

wiping

with acetone 21

with solvent 31, 49

wood, consolidation of 30, 38f

wrappings 24-25, 31, 38, 78, 88-89. *See also: application procedures*

to achieve colorfastness 31

with aluminum foil 24

with cellophane films 72

to exclude oxygen 38

with high-temperature treatments 38

to increase penetration 24-25

with polyethylene films 35, 24-25, 38, 73

with polyethylene netting 74-75

**X**

xylene 50, 59, 65, 66, 68

**Y**

yellowing, of epoxy resins 17, 29, 31, 75.

*See also: discoloration*

removal of, by sandblasting 49



x=2.

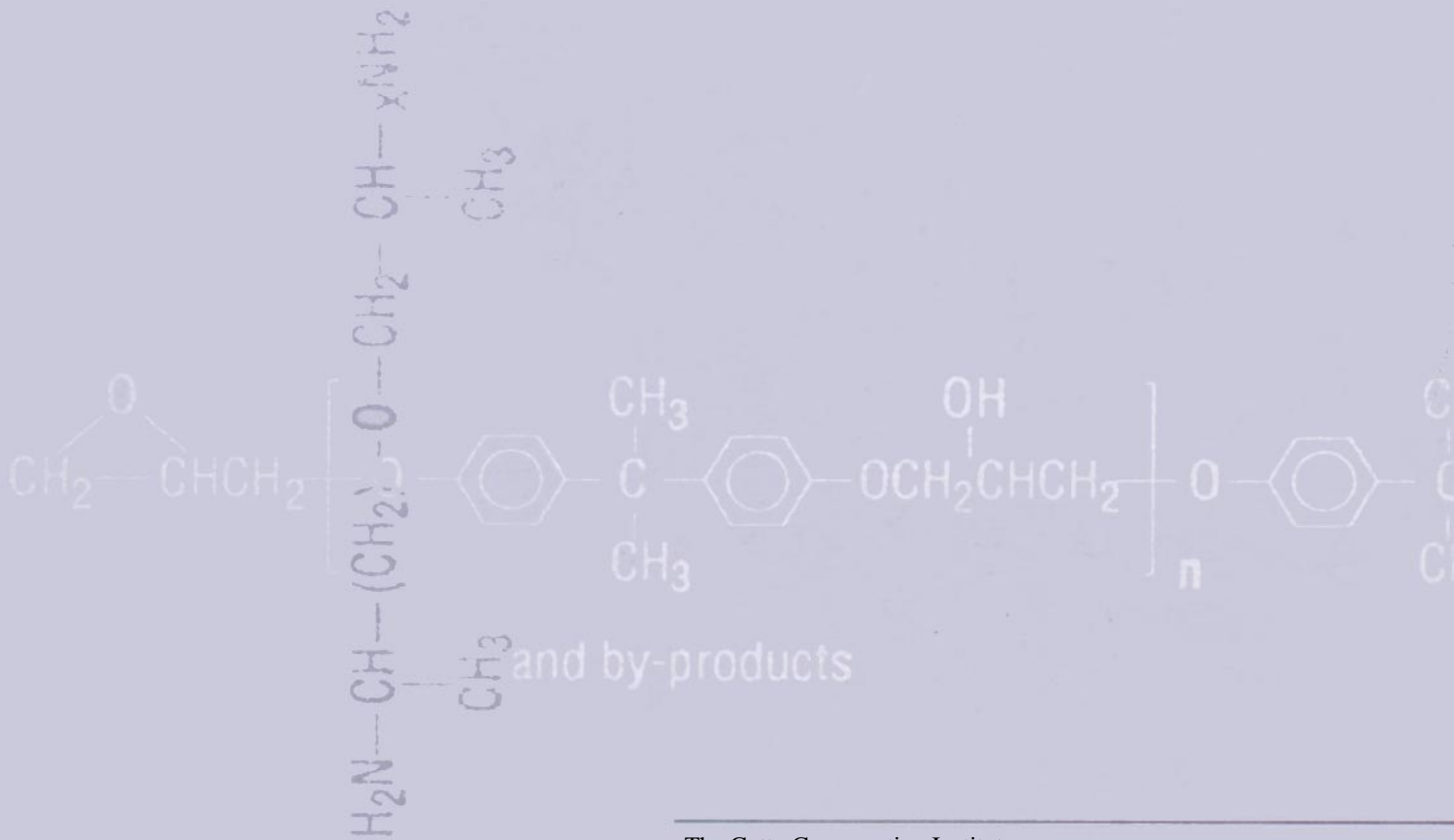

and by-products

The Getty Conservation Institute  
 4503 Glencoe Avenue  
 Marina del Rey, California 90292-6537  
 USA

Telephone: 310 822-2299

